



garant.de

G-TEC® – Die Innovations-Oberfläche G-TEC® – The innovative finish

Hinterlässt keinen Abdruck, sondern Eindruck
Excellent anti-fingerprint properties



Themen

Themes

Seite 04–05 DieTÜR – Digitales Türentool | DieTÜR – Digital door tool

Seite 06–07 Die Premiumkante | The premium edge

Seite 08–09 G-TEC® – Die Innovations-Oberfläche | G-TEC® – The innovative finish

Seite 10–43 **NORMTÜREN-PROGRAMM | STANDARD DOOR RANGE**

Seite 12–41 NORMTÜREN | STANDARD DOORS

Seite 42–43 Gesamtübersicht NORMTÜREN | Overview of all STANDARD DOORS

Seite 44–77 **DESIGNTÜREN-PROGRAMM | DESIGN DOOR RANGE**

Seite 42–75 AURA | AURA

Seite 76–77 Gesamtübersicht DESIGNTÜREN | Overview of all DESIGN DOORS

Seite 78–85 Elemente | Elements

Seite 86–117 **TECHNISCHE DETAILS | TECHNICAL DETAILS**

Seite 88–95 Glas-Übersicht | Glass overview

Seite 96–111 Beschläge | Fittings

Seite 112–113 Kantenausführungen, Bänder | Frame types, hinges

Seite 114–117 G-TEC®-Eigenschaften | G-TEC® properties

Seite 118–119 Maße | Dimensions

Seite 120–123 Gesamtübersicht | General overview



DieTÜR – Digitales Türentool

Über 1 Millionen Kombinationen für Ihre Wunschtür

BEQUEM WUNSCHTÜR KONFIGURIEREN

In einer Türenaussstellung ist nur für eine bestimmte Anzahl an Modellen Platz. Nicht alle Varianten einer Tür können gezeigt werden. Um diese Lücke zu schließen, haben wir das Online-Tool „DieTÜR“ entwickelt. Hierüber haben Sie und Ihre Kunden Zugriff auf über 1 Millionen Kombinationen einer Tür – und mit jedem Update werden es mehr. Ein Highlight bietet die Funktion „Tür im Raum darstellen“. So kann sich der Kunde seine Wunschtür besser in seinem Haus vorstellen.

Außerdem kann er seine Wunschliste samt QR-Code ausdrucken und damit zu Ihnen in den Fachhandel gehen. Vor Ort scannen Sie einfach den QR-Code und wissen sofort, was der Kunde möchte.

QR-CODE AUF DEN FOLGSEITEN SCANNEN UND EINFACH SELBST KOMBINIEREN

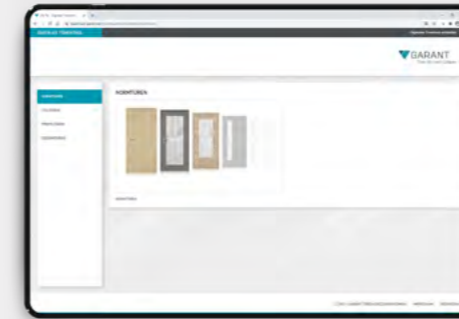
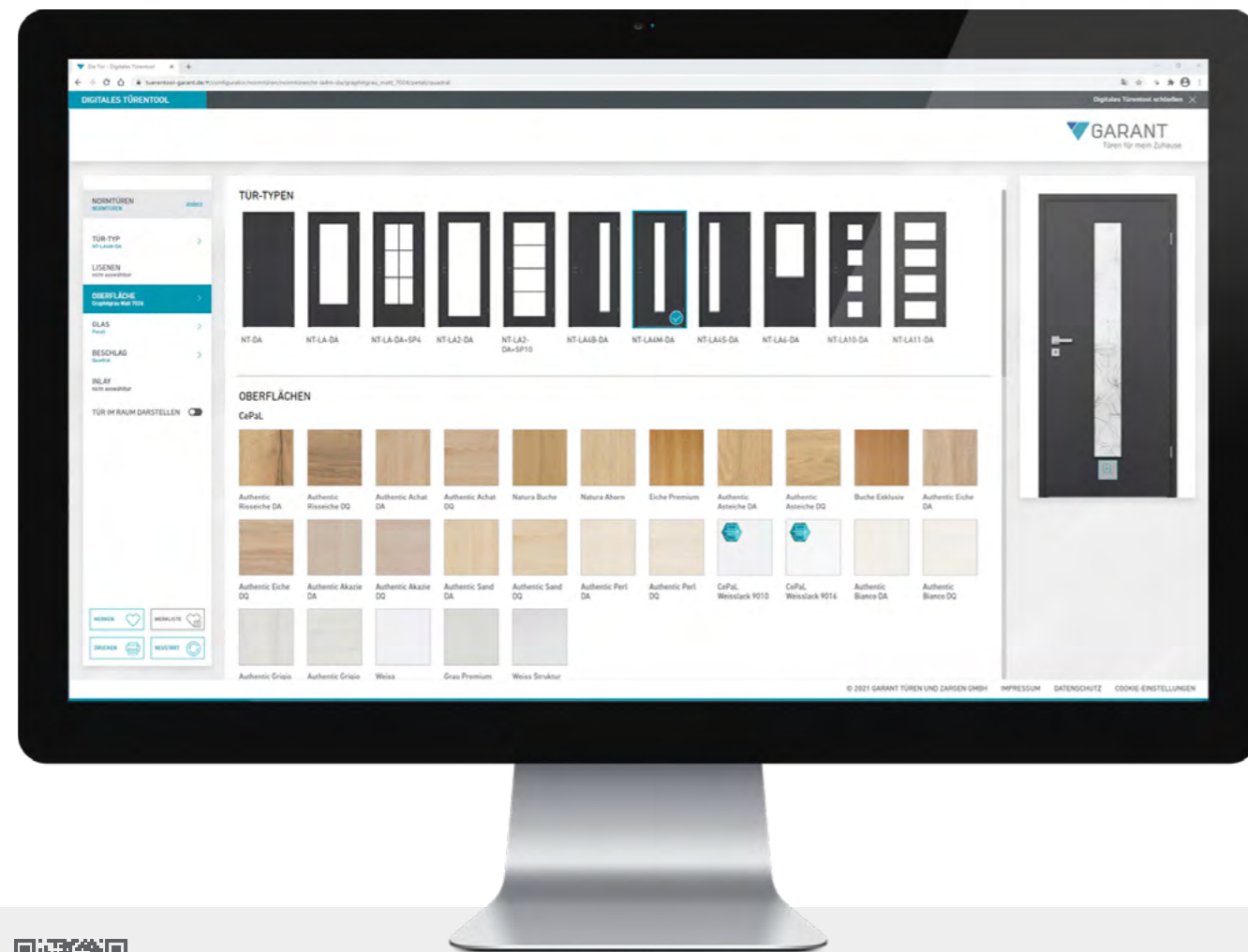

SCHRITT 1:

SO EINFACH FUNKTIONIERT DAS ONLINE-TÜRENTOOL VON GARANT

Im ersten Schritt können Sie oder auch der Kunde daheim zwischen den 4 verschiedenen Türkategorien Norm-, Stil-, Profil- und Designtüren auswählen. Einfach anklicken und Sie landen in der jeweiligen Übersicht. Dort konfigurieren Sie die Wunschtür für Ihren Kunden bis ins kleinste Detail. Ihr Kunde kann auch schon vorarbeiten und trifft eine erste Auswahl vorab zu Hause und Sie beraten detailliert weiter.

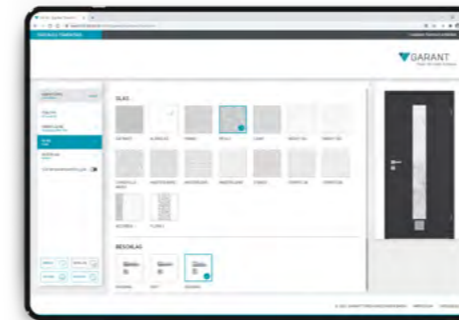

SCHRITT 2:

INDIVIDUALISIERUNG DER TÜR, JETZT AUCH MIT GRIFFWERK-BESCHLÄGEN

Innerhalb der jeweiligen Kategorie können Sie zwischen verschiedenen Türtypen wählen – zum Beispiel mit oder ohne Glas. Oder soll es vielleicht eine Oberfläche in Eiche oder Ahorn sein? Sie haben die Wahl zwischen verschiedensten Oberflächen, Gläsern und Beschlägen. Je nach Türtyp bieten sich unterschiedlich viele Auswahlmöglichkeiten.

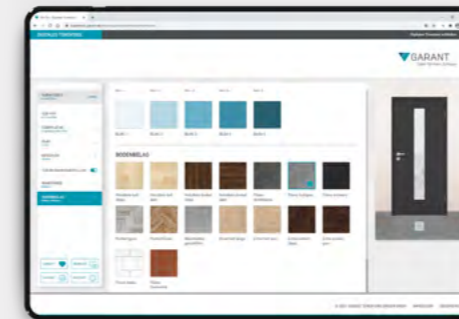

TÜR IM RAUM

Mit einem Klick sieht der Kunde mit der Funktion „Tür im Raum“ seine konfigurierte Wunschtür im Umfeld von Wand und Boden und kann so überprüfen, ob seine Vorstellungen auch stimmig zur Raumsituation – TÜR, BODEN, WAND – passen. Um die beste Kombination zu finden, können Wandfarbe und Bodenbelag farblich passend zur Tür getestet werden.



DAS ERGEBNIS:

BERATUNG UND BESTELLUNG BEIM FACHHÄNDLER

Wenn der Kunde seine Wunschtür zu Hause konfiguriert hat, kann er sie einfach auf den Merkzettel packen oder gleich ausdrucken und damit für eine tiefere Beratung und anschließende Bestellung zu Ihnen gehen.



KLICK

Englische Übersetzung dieser Seite | English translation of this page

Die Premiumkante – erstklassige Kantentechnologie für zahlreiche Einsatzgebiete



Mitten im Leben –
Stoßegal
Das Original von GARANT
mit Nullfugentechnik

Alles zum Thema Premium-
kante finden sie hier:
premiumkante-garant.de



KLICK

Harte Alltagsbelastungen sind unseren Türen mit Premiumkante stoßegal:

Denn die neuartige Funktionsbeschichtung mit Nullfugentechnik sorgt für einzigartige Stoßfestigkeit – und das ist nur einer von vielen Vorteilen:

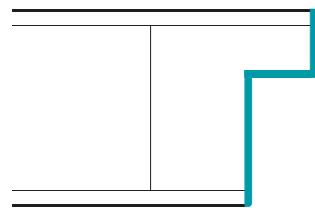

PREMIUMKANTE

Hochwertige Premiumkante
als 2 mm Dickkante

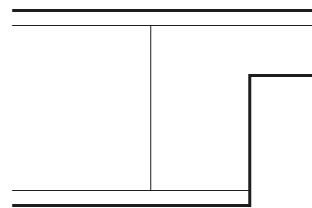

STANDARDKANTE

DIE VORTEILE DER PREMIUMKANTE AUF EINEN BLICK:

- Reduziertes Verletzungsrisiko durch abgerundete Fräsradien im Kantenbereich („Kita-Kante“)
- Sehr niedrige Schmutzanfälligkeit, Reinigung mit haushaltsüblichen Mitteln
- Reinigungsfreundlichkeit durch versiegelte Kantenoberfläche, meist rückstandslose Entfernung von Verschmutzungen möglich
- Hohe Beständigkeit gegenüber Feuchtigkeit und Chemikalien
- Hohe Beständigkeit gegenüber aggressiven Löse- und Reinigungsmitteln
- Erhöhte Stoßfestigkeit (2 mm Dickkante), Absplintern der Kante nicht möglich
- Hohe Farbeständigkeit der Kante im Vergleich zu anderen Systemen
- Zertifizierte Kantenstoßfestigkeit E (KSF-E)

RAL

GÜTEZEICHEN

Innen-
türen

RAL-GZ 426/1
Türblatt (KSF-E)



Erhöhte
Stoßfestigkeit



Hohe
Reinigungsfreundlichkeit



Erhöhte
Feuchtebeständigkeit



Verringerte
Verletzungsgefahr



Verbesserte
Langlebigkeit



KLICK

Englische Übersetzung dieser Seite | English translation of this page

G-TEC® –

Hinterlässt keinen Abdruck, sondern Eindruck und jetzt auch mit Premiumkante

DAS G-TEC®-SORTIMENT VON GARANT

Die GARANT-Oberflächen Graphit-, Staub-, Seidengrau und Weißlack weisen eine qualitativ hochwertige G-TEC®-Oberfläche auf, die eine hochmatte Farbgebung gewährleistet. Diese Elemente garantieren eine angenehme Haptik mit praktischen Antifingerprinteigenschaften. Gerade bei der Wahl einer dunklen Farbe ist es entscheidend, dass selbst bei einer intensiven Nutzung keine Fingerabdrücke zu sehen sind. Zudem bleibt dieser Effekt auch nach einer sanften Reinigung erhalten. Lichtecht und weniger kratzempfindlich steht diese Oberfläche für eine lange Nutzungsdauer und eine gewisse Belastbarkeit.

G-TEC®-Türen und -Zargen können wahlweise mit einer kleinen Rundkante oder Premiumkante ausgestattet werden. Verschiedene Türblattausführungen und Innenlagen können umgesetzt werden. Sie lassen sich ideal mit strukturierten Gläsern sowie Ganzglastüren kombinieren. Unterschiedliche Beschläge aus edlem Stahl oder der interessante Drücker QUADRAL-Inlay runden das Erscheinungsbild ab und ergeben ein bemerkenswertes Spiel mit Stil.



Anti-Fingerprint –
Keine Fingerabdrücke



Hochmatte
Trend-Oberfläche



Weniger kratzempfindlich
≥ 1,5 N nach Erichsen



Verbesserte
Oberflächenruhe



Alle vier Oberflächen
auch mit PK2.0 lieferbar

WEISSLACK MATT 9016

SEIDENGRAU MATT 7044

STAUBGRAU MATT 7037

GRAPHITGRAU MATT 7024

SCHWARZ MATT 9005



Innovations-Oberfläche
G-TEC® – ANTI-FINGERPRINT



Marktübliche Oberfläche



KLICK 

Englische Übersetzung dieser Seite | English translation of this page

Das NORMTÜREN-Programm

The STANDARD DOOR range

Das gute und sichere Gefühl, die richtige Wahl getroffen zu haben:
Unsere NORMTÜREN sorgen jeden Tag für entspannte Wohnlichkeit.

You can be assured of making the right choice because the doors in
our STANDARD range provide comfort and convenience day after day.



Anti-Fingerprint





NORMTÜREN
G-TEC® Weißlack Matt 9016

STANDARD DOORS
G-TEC® Matte White Varnish 9016

Weißlacktüren sind zeitlos schöne Klassiker für jeden Wohnstil. Mit supermatter Oberfläche setzen sie trendige Akzente in jedem Raum.

Classically beautiful white varnish doors have timeless appeal and harmonise with any style of interior design. With an ultra-matte finish they make a stylish addition to any room.





NORMTÜR
G-TEC® Weißlack Matt 9016

Wohnliche Eleganz in
Weiß mit modernem Touch.

Homely elegance in white with
a modern touch.

Selbstverständlich unempfindlich.
Naturally robust.

QUERSCHNITT | CROSS

KLEINE RUNDKANTE | SMALL ROUNDED EDGE



Lichtausschnitt-Türen geschlossene Türen



PREMIUMKANTE | PREMIUM EDGE



Lichtausschnitt-Türen geschlossene Türen



BESCHLAG
QUATTRA INLAY

GRAPHITSCHWARZ
GRAPHITE BLACK



BB/PZ/WC



smart2lock

EDELSTAHL MATT
STAINLESS STEEL MATT



BB/PZ/WC



smart2lock



MODELL 1 NORMTÜR NT-DA
OBERFLÄCHE G-TEC® Weißlack Matt 9016
GLAS -
ZARGE KR1
BESCHLAG QUATTRA INLAY, Graphitschwarz
MODEL STANDARD DOOR NT-DA
FINISH G-TEC® Matte White Varnish 9016
GLASS -
FRAME KR1
FITTINGS QUATTRA INLAY, Graphite black

2 NORMTÜR NT-LA11-DA
G-TEC® Weißlack Matt 9016
SATINATO, Standard-Ornamentglas
KR1
QUATTRA INLAY, Graphitschwarz
STANDARD DOOR NT-LA11-DA
G-TEC® Matte White Varnish 9016
SATINATO, standard patterned glass
KR1
QUATTRA INLAY, Graphite black

3 NORMTÜR NT-LA-DA
G-TEC® Weißlack Matt 9016
SATINATO, Standard-Ornamentglas
KR1
QUATTRA INLAY, Graphitschwarz
STANDARD DOOR NT-LA-DA
G-TEC® Matte White Varnish 9016
SATINATO, standard patterned glass
KR1
QUATTRA INLAY, Graphite black

4 NORMTÜR NT-LA-DA+SP4
G-TEC® Weißlack Matt 9016
SATINATO, Standard-Ornamentglas
KR1
QUATTRA INLAY, Graphitschwarz
STANDARD DOOR NT-LA-DA+SP4
G-TEC® Matte White Varnish 9016
SATINATO, standard patterned glass
KR1
QUATTRA INLAY, Graphite black

5 NORMTÜR NT-LA4S-DA
G-TEC® Weißlack Matt 9016
SATINATO, Standard-Ornamentglas
KR1
QUATTRA INLAY, Edelhloptik Matt
STANDARD DOOR NT-LA4S-DA
G-TEC® Matte White Varnish 9016
SATINATO, standard patterned glass
KR1
QUATTRA INLAY, Matt stainless steel look

6 NORMTÜR NT-LA4M-DA
G-TEC® Weißlack Matt 9016
SATINATO, Standard-Ornamentglas
KR1
QUATTRA INLAY, Edelhloptik Matt
STANDARD DOOR NT-LA4M-DA
G-TEC® Matte White Varnish 9016
SATINATO, standard patterned glass
KR1
QUATTRA INLAY, Matt stainless steel look

7 NORMTÜR NT-LA2-DA
G-TEC® Weißlack Matt 9016
PANNO, Design-Ornamentglas
KR1
QUATTRA INLAY, Edelhloptik Matt
STANDARD DOOR NT-LA2-DA
G-TEC® Matte White Varnish 9016
PANNO, design patterned glass
KR1
QUATTRA INLAY, Matt stainless steel look



JETZT TESTEN
Im Online-Türentool „DieTÜR“ von GARANT kombinieren Sie mit einfachen Klicks Ihre individuelle Wunschtür.
TEST NOW
Use GARANT's online door tool "DieTÜR" to create your own custom door in just a few clicks.



Hochmatte Oberfläche



Anti-Fingerprint



G-TEC® Weißlack Matt 9016
G-TEC® Matte White Varnish 9016

Weißlacktüren mit hochmatter Oberfläche wirken in einem klassisch-urbanen Wohnambiente besonders edel und elegant. Ihre moderne Optik und die samtweiche Haptik verleihen Räumen das gewisse Extra. White varnish doors with an ultra-matte finish make an elegant addition to classic urban interiors. Their modern appearance and velvet-soft feel add a special touch to any room.



NORMTÜREN
G-TEC® Seidengrau Matt 7044

STANDARD DOORS
G-TEC® Matte Silk Grey 7044

Seidengrau strahlt Wärme und Wertigkeit zugleich aus. Kombiniert mit gedeckten Wandfarben und Holzfußböden ist diese Oberfläche der ideale Begleiter eines jungen Familien-Wohnstils.

Silk grey exudes both warmth and exclusivity. In combination with a neutral-coloured wall and wooden flooring, this door is perfect for a young family home environment.





NORMTÜR
G-TEC® Seidengrau Matt 7044

Trendig aktuell für den jungen, frischen Wohnstil.

Trendy and modern for a young and fresh lifestyle.

Trotz jedem Fingerabdruck.
 Excellent anti-fingerprint properties.

QUERSCHNITT | CROSS

KLEINE RUNDKANTE | SMALL ROUNDED EDGE



PREMIUMKANTE | PREMIUM EDGE



BESCHLAG
NOVO

GRAPHITSCHWARZ
GRAPHITE BLACK



BB/PZ/WC



smart2lock

EDELSTAHL MATT
STAINLESS STEEL MATT



BB/PZ/WC



smart2lock



MODELL 1 NORMTÜR NT-DA
OBERFLÄCHE G-TEC® Seidengrau Matt 7044
GLAS -
ZARGE KR1
BESCHLAG NOVO, Graphitschwarz
MODEL STANDARD DOOR NT-DA
FINISH G-TEC® Matte Silk Grey 7044
GLASS -
FRAME KR1
FITTINGS NOVO, Graphite black

MODELL 2 NORMTÜR NT-LA11-DA
OBERFLÄCHE G-TEC® Seidengrau Matt 7044
GLAS SATINATO, Standard-Ornamentglas
ZARGE KR1
BESCHLAG NOVO, Graphitschwarz
MODEL STANDARD DOOR NT-LA11-DA
FINISH G-TEC® Matte Silk Grey 7044
GLASS SATINATO, standard patterned glass
FRAME KR1
FITTINGS NOVO, Graphite black

MODELL 3 NORMTÜR NT-LA-DA
OBERFLÄCHE G-TEC® Seidengrau Matt 7044
GLAS SATINATO, Standard-Ornamentglas
ZARGE KR1
BESCHLAG NOVO, Graphitschwarz
MODEL STANDARD DOOR NT-LA-DA
FINISH G-TEC® Matte Silk Grey 7044
GLASS SATINATO, standard patterned glass
FRAME KR1
FITTINGS NOVO, Graphite black

MODELL 4 NORMTÜR NT-LA-DA+SP4
OBERFLÄCHE G-TEC® Seidengrau Matt 7044
GLAS SATINATO, Standard-Ornamentglas
ZARGE KR1
BESCHLAG NOVO, Graphitschwarz
MODEL STANDARD DOOR NT-LA-DA+SP4
FINISH G-TEC® Matte Silk Grey 7044
GLASS SATINATO, standard patterned glass
FRAME KR1
FITTINGS NOVO, Graphite black

MODELL 5 NORMTÜR NT-LA4S-DA
OBERFLÄCHE G-TEC® Seidengrau Matt 7044
GLAS SATINATO, Standard-Ornamentglas
ZARGE KR1
BESCHLAG NOVO, Edelstahl Matt
MODEL STANDARD DOOR NT-LA4S-DA
FINISH G-TEC® Matte Silk Grey 7044
GLASS SATINATO, standard patterned glass
FRAME KR1
FITTINGS NOVO, Stainless steel matt

MODELL 6 NORMTÜR NT-LA4M-DA
OBERFLÄCHE G-TEC® Seidengrau Matt 7044
GLAS SATINATO, Standard-Ornamentglas
ZARGE KR1
BESCHLAG NOVO, Edelstahl Matt
MODEL STANDARD DOOR NT-LA4M-DA
FINISH G-TEC® Matte Silk Grey 7044
GLASS SATINATO, standard patterned glass
FRAME KR1
FITTINGS NOVO, Stainless steel matt

MODELL 7 NORMTÜR NT-LA2-DA
OBERFLÄCHE G-TEC® Seidengrau Matt 7044
GLAS STRATO, Siebdruck-Veredelung
ZARGE KR1
BESCHLAG NOVO, Edelstahl Matt
MODEL STANDARD DOOR NT-LA2-DA
FINISH G-TEC® Matte Silk Grey 7044
GLASS STRATO, screen printed décor
FRAME KR1
FITTINGS NOVO, Stainless steel matt



JETZT TESTEN
 Im Online-Türentool „DieTÜR“ von GARANT kombinieren Sie mit einfachen Klicks Ihre individuelle Wunschtür.
TEST NOW
 Use GARANT's online door tool 'DieTÜR' to create your own custom door in just a few clicks.

MATT

Hochmatte Oberfläche



Anti-Fingerprint



G-TEC® Seidengrau Matt 7044
G-TEC® Matte Silk Grey 7044

Für ein schönes Zuhause. Hochmattes Seidengrau wirkt elegant und doch natürlich entspannt.
Mit diesen Türen werden Räume zur echten Wohlfühlzone für die ganze Familie.
For a beautiful home. Ultra-matte silk grey has an elegant yet informal appearance.
These doors turn rooms into genuine oases of well-being for the whole family.



NORMTÜREN
G-TEC® Staubgrau Matt 7037

STANDARD DOORS
G-TEC® Matte Dusty Grey 7037

Eine Oberfläche, die besonders in Kombination mit hohen Decken, Stuckleisten und edlen Holzböden überzeugt. Im modernen Altbau ist sie ein stilvoller Blickfang.

A finish that looks exceptionally good in combination with high ceilings, plaster cornices and fine wood flooring.

It is an eye-catching feature in any modernly-furnished old building.



NORMTÜR
G-TEC® Staubgrau Matt 7037

Die klassisch-moderne
Oberfläche in nobler Eleganz.

A classic-modern finish
that exudes upmarket elegance.

Unterstreicht eine stilvolle Wohnkultur.
Underlining the stylish interior.

QUERSCHNITT | CROSS

KLEINE RUNDKANTE | SMALL ROUNDED EDGE



PREMIUMKANTE | PREMIUM EDGE

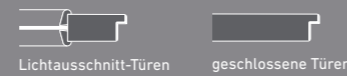

BESCHLAG
MONO

GRAPHITSCHWARZ
GRAPHITE BLACK



BB/PZ/WC



smart2lock

EDELSTAHL MATT
STAINLESS STEEL MATT



BB/PZ/WC



smart2lock



MODELL 1 NORMTÜR NT-DA
OBERFLÄCHE G-TEC® Staubgrau Matt 7037
GLAS -
ZARGE KR1
BESCHLAG MONO, Graphitschwarz
MODEL STANDARD DOOR NT-DA
FINISH G-TEC® Matte Dusty Grey 7037
GLASS -
FRAME KR1
FITTINGS MONO, Graphite black

MODELL 2 NORMTÜR NT-LA11-DA
OBERFLÄCHE G-TEC® Staubgrau Matt 7037
GLAS SATINATO, Standard-Ornamentglas
ZARGE KR1
BESCHLAG MONO, Graphitschwarz
MODEL STANDARD DOOR NT-LA11-DA
FINISH G-TEC® Matte Dusty Grey 7037
GLASS SATINATO, standard patterned glass
FRAME KR1
FITTINGS MONO, Graphite black

MODELL 3 NORMTÜR NT-LA-DA
OBERFLÄCHE G-TEC® Staubgrau Matt 7037
GLAS SATINATO, Standard-Ornamentglas
ZARGE KR1
BESCHLAG MONO, Graphitschwarz
MODEL STANDARD DOOR NT-LA-DA
FINISH G-TEC® Matte Dusty Grey 7037
GLASS SATINATO, standard patterned glass
FRAME KR1
FITTINGS MONO, Graphite black

MODELL 4 NORMTÜR NT-LA-DA+SP4
OBERFLÄCHE G-TEC® Staubgrau Matt 7037
GLAS SATINATO, Standard-Ornamentglas
ZARGE KR1
BESCHLAG MONO, Graphitschwarz
MODEL STANDARD DOOR NT-LA-DA+SP4
FINISH G-TEC® Matte Dusty Grey 7037
GLASS SATINATO, standard patterned glass
FRAME KR1
FITTINGS MONO, Graphite black

MODELL 5 NORMTÜR NT-LA4S-DA
OBERFLÄCHE G-TEC® Staubgrau Matt 7037
GLAS SATINATO, Standard-Ornamentglas
ZARGE KR1
BESCHLAG MONO, Edelstahl Matt
MODEL STANDARD DOOR NT-LA4S-DA
FINISH G-TEC® Matte Dusty Grey 7037
GLASS SATINATO, standard patterned glass
FRAME KR1
FITTINGS MONO, Stainless steel matt

MODELL 6 NORMTÜR NT-LA4M-DA
OBERFLÄCHE G-TEC® Staubgrau Matt 7037
GLAS SATINATO, Standard-Ornamentglas
ZARGE KR1
BESCHLAG MONO, Edelstahl Matt
MODEL STANDARD DOOR NT-LA4M-DA
FINISH G-TEC® Matte Dusty Grey 7037
GLASS SATINATO, standard patterned glass
FRAME KR1
FITTINGS MONO, Stainless steel matt

MODELL 7 NORMTÜR NT-LA2-DA
OBERFLÄCHE G-TEC® Staubgrau Matt 7037
GLAS PETALI, Design-Ornamentglas
ZARGE KR1
BESCHLAG MONO, Edelstahl Matt
MODEL STANDARD DOOR NT-LA2-DA
FINISH G-TEC® Matte Dusty Grey 7037
GLASS PETALI, design patterned glass
FRAME KR1
FITTINGS MONO, Stainless steel matt



JETZT TESTEN
Im Online-Türentool „DieTÜR“ von GARANT kombinieren Sie mit einfachen Klicks Ihre individuelle Wunschtür.
TEST NOW
Use GARANT's online door tool "DieTÜR" to create your own custom door in just a few clicks.



MATT

Hochmatte Oberfläche



Anti-Fingerprint



G-TEC® Staubgrau Matt 7037
G-TEC® Matte Dusty Grey 7037

Der kühle Grauton wirkt edel und doch neutral. Mit ihrer besonderen Ästhetik und samtig-weichen Haptik setzen diese Oberflächen die richtigen Akzente in der Raumgestaltung – von traditionell bis klassisch-modern. Cool dusty grey creates an elegant and neutral setting. Aesthetic appearance and a velvet-soft feel make these doors the highlights of any interior design concept – from traditional to classic-modern.



NORMTÜREN
G-TEC® Graphitgrau Matt 7024

STANDARD DOORS
G-TEC® Matte Graphite Grey 7024

Die Türoberflächen aus kühlem Graphitgrau stehen für Klarheit und Ruhe und sind in jeder Arbeitsumgebung die perfekte Ausstattung.
The door finishes in cool graphite grey represent clarity and tranquillity; and they are perfect for any work environment.





NORMTÜR
G-TEC® Graphitgrau Matt 7024

Ein klares Designstatement
für das Office-Ambiente.

A distinctive office design
statement.

Strahlkraft und Modernität in edlem Grau.
A beautiful and charismatic modern grey.

QUERSCHNITT | CROSS

KLEINE RUNDKANTE | SMALL ROUNDED EDGE



PREMIUMKANTE | PREMIUM EDGE

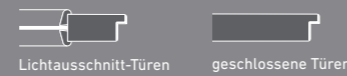

BESCHLAG
CUBO

GRAPHITSCHWARZ
GRAPHITE BLACK

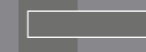

BB/PZ/WC



smart2lock

EDELSTAHL MATT
STAINLESS STEEL MATT



BB/PZ/WC



smart2lock



1 **NORMTÜR NT-DA**
G-TEC® Graphitgrau Matt 7024
GLAS -
ZARGE KR1
BESCHLAG CUBO, Graphitschwarz
MODEL STANDARD DOOR NT-DA
FINISH G-TEC® Matte Graphite Grey 7024
GLASS -
FRAME KR1
FITTINGS CUBO, Graphite black



2 **NORMTÜR NT-LA11-DA**
G-TEC® Graphitgrau Matt 7024
GLAS SATINATO, Standard-Ornamentglas
ZARGE KR1
BESCHLAG CUBO, Graphitschwarz
MODEL STANDARD DOOR NT-LA11-DA
FINISH G-TEC® Matte Graphite Grey 7024
GLASS SATINATO, standard patterned glass
FRAME KR1
FITTINGS CUBO, Graphite black



3 **NORMTÜR NT-LA-DA**
G-TEC® Graphitgrau Matt 7024
GLAS SATINATO, Standard-Ornamentglas
ZARGE KR1
BESCHLAG CUBO, Graphitschwarz
MODEL STANDARD DOOR NT-LA-DA
FINISH G-TEC® Matte Graphite Grey 7024
GLASS SATINATO, standard patterned glass
FRAME KR1
FITTINGS CUBO, Graphite black



4 **NORMTÜR NT-LA-DA+SP4**
G-TEC® Graphitgrau Matt 7024
GLAS SATINATO, Standard-Ornamentglas
ZARGE KR1
BESCHLAG CUBO, Graphitschwarz
MODEL STANDARD DOOR NT-LA-DA+SP4
FINISH G-TEC® Matte Graphite Grey 7024
GLASS SATINATO, standard patterned glass
FRAME KR1
FITTINGS CUBO, Graphite black

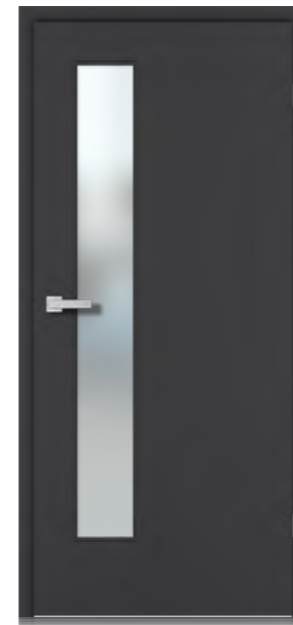

5 **NORMTÜR NT-LA4S-DA**
G-TEC® Graphitgrau Matt 7024
GLAS SATINATO, Standard-Ornamentglas
ZARGE KR1
BESCHLAG CUBO, Edelstahl Matt
MODEL STANDARD DOOR NT-LA4S-DA
FINISH G-TEC® Matte Graphite Grey 7024
GLASS SATINATO, standard patterned glass
FRAME KR1
FITTINGS CUBO, Stainless steel matt



6 **NORMTÜR NT-LA4M-DA**
G-TEC® Graphitgrau Matt 7024
GLAS SATINATO, Standard-Ornamentglas
ZARGE KR1
BESCHLAG CUBO, Edelstahl Matt
MODEL STANDARD DOOR NT-LA4M-DA
FINISH G-TEC® Matte Graphite Grey 7024
GLASS SATINATO, standard patterned glass
FRAME KR1
FITTINGS CUBO, Stainless steel matt



7 **NORMTÜR NT-LA2-DA**
G-TEC® Graphitgrau Matt 7024
GLAS STRIPES-DA, Siebdruck-Veredelung
ZARGE KR1
BESCHLAG CUBO, Edelstahl Matt
MODEL STANDARD DOOR NT-LA2-DA
FINISH G-TEC® Matte Graphite Grey 7024
GLASS STRIPES-DA, screen printed décor
FRAME KR1
FITTINGS CUBO, Stainless steel matt



JETZT TESTEN
Im Online-Türentool „DieTÜR“ von GARANT kombinieren Sie mit einfachen Klicks Ihre individuelle Wunschtür.
TEST NOW
Use GARANT's online door tool 'DieTÜR' to create your own custom door in just a few clicks.



MATT

Hochmatte Oberfläche



Anti-Fingerprint



G-TEC® Graphitgrau Matt 7024
G-TEC® Matte Graphite Grey 7024

Für ein stilvolles Office-Setting im schönsten Graphit-Design. Die grauen, hochmatten Oberflächen zeigen sich edel und strapazierfähig zugleich. Auch viele Hände hinterlassen hier keine störenden Spuren.
For a stylish office setting in a beautiful graphite design. The grey, ultra-matte finishes are both elegant and hard-wearing. It makes no difference how many hands they come into contact with, there are never any annoying marks.



NORMTÜREN
G-TEC® Schwarz Matt 9005

STANDARD DOORS
G-TEC® Matte Black 9005

Mattes Schwarz entfaltet seine klare Wirkung in Kombination mit Holz und gedeckten Tönen. Eine Oberfläche mit Format und zeitloser Eleganz.

Matte black looks absolutely stunning in combination with wood and subdued shades. A finish with substance and timeless elegance.





NORMTÜR
G-TEC® Schwarz Matt 9005

Stilprägend für
 modernes Wohnen.

Distinctive style
 for modern living.

Die edle Note in Mattschwarz.
 An elegant touch in matte black.

QUERSCHNITT | CROSS

KLEINE RUNDKANTE | SMALL ROUNDED EDGE

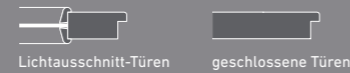

PREMIUMKANTE | PREMIUM EDGE

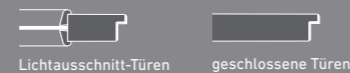

BESCHLAG
CUBO

GRAPHITSCHWARZ
GRAPHITE BLACK



BB/PZ/WC



smart2lock

EDELSTAHL MATT
STAINLESS STEEL MATT



BB/PZ/WC



smart2lock



1 **NORMTÜR NT-DA**
 G-TEC® Schwarz Matt 9005
GLAS -
ZARGE KR1
BESCHLAG CUBO, Graphitschwarz
MODEL STANDARD DOOR NT-DA
FINISH G-TEC® Matte Black 9005
GLASS -
FRAME KR1
FITTINGS CUBO, Graphite black



2 **NORMTÜR NT-LA11-DA**
 G-TEC® Schwarz Matt 9005
SATINATO, Standard-Ornamentglas
KR1
CUBO, Graphitschwarz
MODEL STANDARD DOOR NT-LA11-DA
FINISH G-TEC® Matte Black 9005
SATINATO, standard patterned glass
KR1
CUBO, Graphite black



3 **NORMTÜR NT-LA-DA**
 G-TEC® Schwarz Matt 9005
SATINATO, Standard-Ornamentglas
KR1
CUBO, Graphitschwarz
MODEL STANDARD DOOR NT-LA-DA
FINISH G-TEC® Matte Black 9005
SATINATO, standard patterned glass
KR1
CUBO, Graphite black



4 **NORMTÜR NT-LA-DA+SP4**
 G-TEC® Schwarz Matt 9005
SATINATO, Standard-Ornamentglas
KR1
CUBO, Graphitschwarz
MODEL STANDARD DOOR NT-LA-DA+SP4
FINISH G-TEC® Matte Black 9005
SATINATO, standard patterned glass
KR1
CUBO, Graphite black



5 **NORMTÜR NT-LA4S-DA**
 G-TEC® Schwarz Matt 9005
SATINATO, Standard-Ornamentglas
KR1
CUBO, Edelstahl Matt
MODEL STANDARD DOOR NT-LA4S-DA
FINISH G-TEC® Matte Black 9005
SATINATO, standard patterned glass
KR1
CUBO, Stainless steel matt



6 **NORMTÜR NT-LA4M-DA**
 G-TEC® Schwarz Matt 9005
SATINATO, Standard-Ornamentglas
KR1
CUBO, Edelstahl Matt
MODEL STANDARD DOOR NT-LA4M-DA
FINISH G-TEC® Matte Black 9005
SATINATO, standard patterned glass
KR1
CUBO, Stainless steel matt



7 **NORMTÜR NT-LA2-DA**
 G-TEC® Schwarz Matt 9005
PANNO, Siebdruck-Veredelung
KR1
CUBO, Edelstahl Matt
MODEL STANDARD DOOR NT-LA2-DA
FINISH G-TEC® Matte Black 9005
PANNO, screen printed décor
KR1
CUBO, Stainless steel matt



JETZT TESTEN
 Im Online-Türentool „DieTÜR“ von GARANT kombinieren Sie mit einfachen Klicks Ihre individuelle Wunschtür.
TEST NOW
 Use GARANT's online door tool "DieTÜR" to create your own custom door in just a few clicks.



Hochmatte Oberfläche



Anti-Fingerprint



G-TEC® Schwarz Matt 9005
G-TEC® Matte Black 9005

Das hat Stil: Hochmattes Schwarz ist im modern gestalteten Zuhause immer salonfähig.
Ein echter „Touch of Class“ ganz ohne Anfälligkeit für störende Abdrücke auf den Oberflächen.
That's style for you: ultra-matte black is never out of place in a modern home environment.
A genuine touch of class with zero susceptibility to annoying surface smudges.

Gesamtübersicht NORMTÜREN-Programm

Overview of the STANDARD DOOR range

NORMTÜREN | STANDARD DOORS

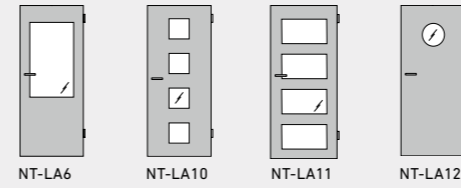
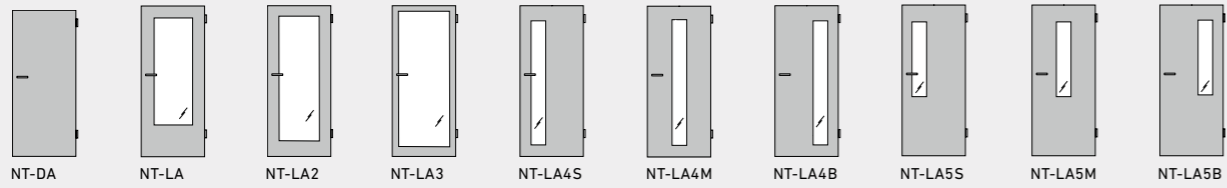

OBERFLÄCHEN | FINISHES



TÜRKANTEN | EDGES



GLÄSER | GLASS PANELS

MODERNE ORNAMENTGLÄSER | MODERN PATTERNED GLASS PANELS

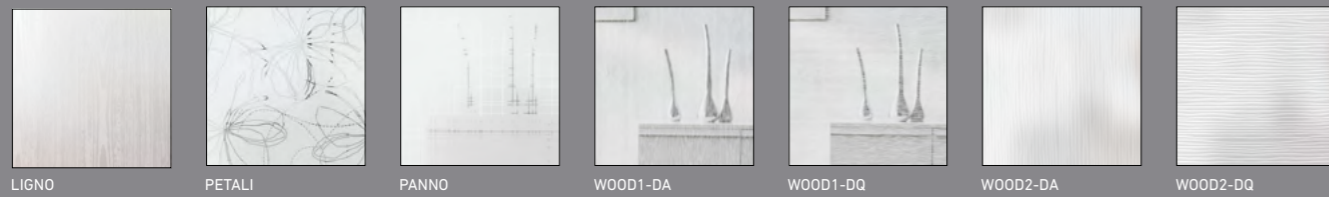

DESIGNGLÄSER – SIEBDRUCK-VEREDELUNG | DESIGN GLASS PANELS – SCREEN PRINTED DÉCOR

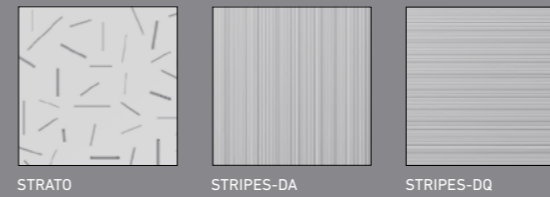

KLASSISCHE ORNAMENTGLÄSER | CLASSIC PATTERNED GLASS PANELS



TOP-BESCHLÄGE | TOP-FERRURE

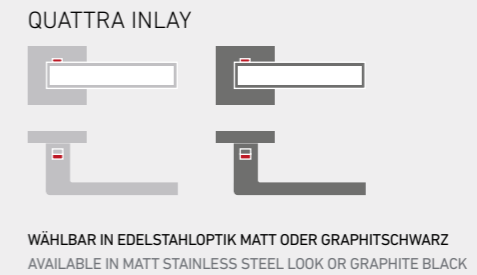
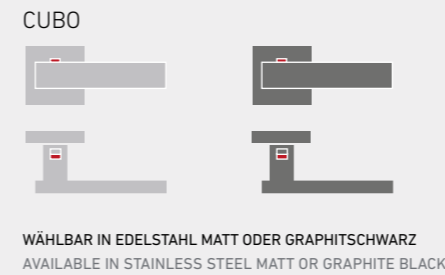
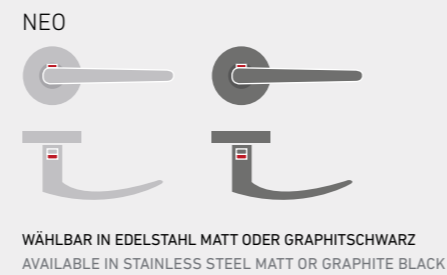
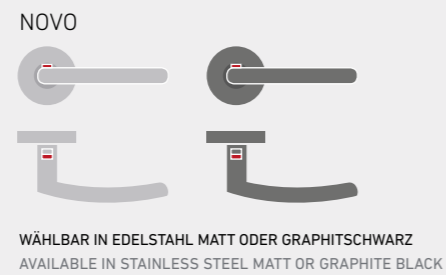
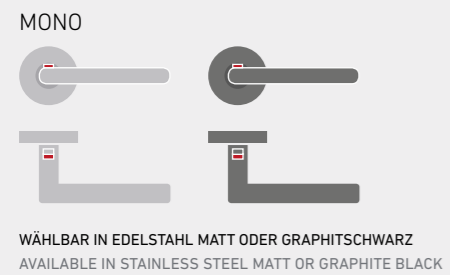

INLAYS | INLAYS



Das DESIGNTÜREN-Programm

The DESIGN DOOR range

RAUM FÜR DESIGN

Mit den Modellen unseres DESIGNTÜREN-Programms werden Wohnwelten gestaltet.

SPACE FOR DESIGN

The models in the DESIGN DOOR range can be used to create design worlds.



Anti-Fingerprint

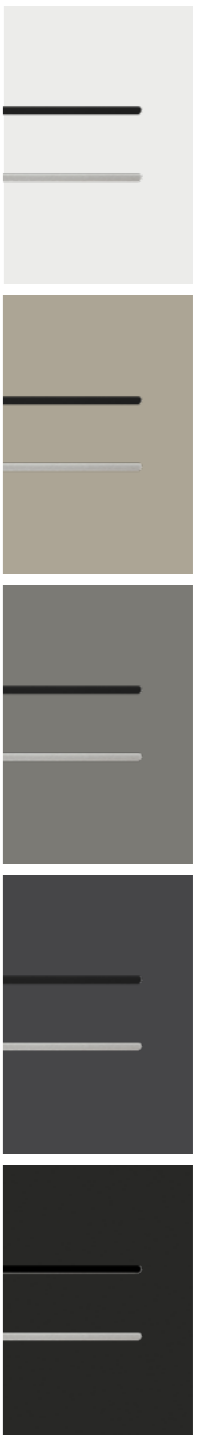



DESIGNTÜREN
AURA G-TEC® Weißlack Matt 9016

DESIGN DOORS
G-TEC® Matte White Varnish 9016

Hightech trifft urbanes Design: Die matte Weißlack-Oberfläche ist mit schwarzen oder Edelstahl-Lisenen das optische Highlight für den modernen City-Style.

High-tech meets urban design: the matte white varnish surface with black or stainless steel pilasters is a real highlight in any modern city-style setting.



AURA
G-TEC® Weißlack Matt 9016

Hochmoderner Blickfang mit
einzigartiger Designsprache.

An ultra-modern look with a unique
design language.

Außergewöhnlich ansprechende Optik.
And exceptional appeal.

QUERSCHNITT | CROSS

KLEINE RUNDKANTE | SMALL ROUNDED EDGE



PREMIUMKANTE | PREMIUM EDGE



BESCHLAG
CUBO

GRAPHITSCHWARZ
GRAPHITE BLACK



BB/PZ/WC



smart2lock

EDELSTAHL MATT
STAINLESS STEEL MATT



BB/PZ/WC



smart2lock



MODELL 1 AURA A830
OBERFLÄCHE G-TEC® Weißlack Matt 9016
GLAS -
ZARGE KR1
BESCHLAG CUBO, Graphitschwarz
MODEL AURA A830
FINISH G-TEC® Matte White Varnish 9016
GLASS -
FRAME KR1
FITTINGS CUBO, Graphite black

MODELL 2 AURA A830-LA4M
OBERFLÄCHE G-TEC® Weißlack Matt 9016
GLAS SATINATO, Standard-Ornamentglas
ZARGE KR1
BESCHLAG CUBO, Graphitschwarz
MODEL AURA A830-LA4M
FINISH G-TEC® Matte White Varnish 9016
GLASS SATINATO, standard patterned glass
FRAME KR1
FITTINGS CUBO, Graphite black

MODELL 3 AURA A834
OBERFLÄCHE G-TEC® Weißlack Matt 9016
GLAS -
ZARGE KR1
BESCHLAG CUBO, Graphitschwarz
MODEL AURA A834
FINISH G-TEC® Matte White Varnish 9016
GLASS -
FRAME KR1
FITTINGS CUBO, Graphite black

MODELL 4 AURA A834-LA4S
OBERFLÄCHE G-TEC® Weißlack Matt 9016
GLAS SATINATO, Standard-Ornamentglas
ZARGE KR1
BESCHLAG CUBO, Graphitschwarz
MODEL AURA A834-LA4S
FINISH G-TEC® Matte White Varnish 9016
GLASS SATINATO, standard patterned glass
FRAME KR1
FITTINGS CUBO, Graphite black

MODELL 5 AURA A850
OBERFLÄCHE G-TEC® Weißlack Matt 9016
GLAS -
ZARGE KR1
BESCHLAG CUBO, Edelstahl Matt
MODEL AURA A850
FINISH G-TEC® Matte White Varnish 9016
GLASS -
FRAME KR1
FITTINGS CUBO, Stainless steel matt

MODELL 6 AURA A851
OBERFLÄCHE G-TEC® Weißlack Matt 9016
GLAS -
ZARGE KR1
BESCHLAG CUBO, Edelstahl Matt
MODEL AURA A851
FINISH G-TEC® Matte White Varnish 9016
GLASS -
FRAME KR1
FITTINGS CUBO, Stainless steel matt

MODELL 7 AURA A831
OBERFLÄCHE G-TEC® Weißlack Matt 9016
GLAS -
ZARGE KR1
BESCHLAG CUBO, Edelstahl Matt
MODEL AURA A831
FINISH G-TEC® Matte White Varnish 9016
GLASS -
FRAME KR1
FITTINGS CUBO, Stainless steel matt



JETZT TESTEN
Im Online-Türentool „DieTÜR“ von GARANT kombinieren Sie mit einfachen Klicks Ihre individuelle Wunschtür.
TEST NOW
Use GARANT's online door tool 'DieTÜR' to create your own custom door in just a few clicks.

Lisene Matt-Schwarz

Lisene Edelstahloptik



Hochmatte Oberfläche



Anti-Fingerprint



AURA G-TEC® Weißlack Matt 9016
AURA G-TEC® Matte White Varnish 9016

Diese Design-Oberfläche ist ein starkes Statement für die wertige Raumgestaltung im Arbeitsumfeld oder Homeoffice. Quer laufende Lisenen sind hier extravaganter Blickfang.

This design finish makes a strong statement in an exclusive living or work environment. Transverse pilaster strips add a distinctively extravagant detail.



DESIGNTÜREN
AURA G-TEC® Seidengrau Matt 7044

DESIGN DOORS
AURA G-TEC® Matte Silk Grey 7044

Die seidengraue Oberfläche mit Matt-Schwarzen- oder Edelstahl-Lisenen ist die perfekte Design-Kombination für den klassisch-modernen Wohnstil mit gedeckten Farben und Holztönen.

The silk grey finish with matte-black or stainless steel pilaster strips is the perfect design formula for a classic-modern living environment with muted colour schemes and wood features.





AURA
G-TEC® Seidengrau Matt 7044

Besticht in der Kombination
mit erdigen Naturtönen.

Captivating in combination with
natural earthy shades.

Warme Atmosphäre auf der ganzen Linie.
A warm atmosphere through and through.

QUERSCHNITT | CROSS

KLEINE RUNDKANTE | SMALL ROUNDED EDGE

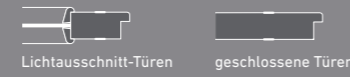

PREMIUMKANTE | PREMIUM EDGE

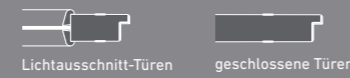

BESCHLAG
NOVO

GRAPHITSCHWARZ
GRAPHITE BLACK



BB/PZ/WC



smart2lock

EDELSTAHL MATT
STAINLESS STEEL MATT



BB/PZ/WC



smart2lock



MODELL	1 AURA A832
OBERFLÄCHE	G-TEC® Seidengrau Matt 7044
GLAS	-
ZARGE	KR1
BESCHLAG	NOVO, Graphitschwarz
MODEL	AURA A832
FINISH	G-TEC® Matte Silk Grey 7044
GLASS	-
FRAME	KR1
FITTINGS	NOVO, Graphite black

MODELL	2 AURA A832-LA4M
OBERFLÄCHE	G-TEC® Seidengrau Matt 7044
GLAS	SATINATO, Standard-Ornamentglas
ZARGE	KR1
BESCHLAG	NOVO, Graphitschwarz
MODEL	AURA A832-LA4M
FINISH	G-TEC® Matte Silk Grey 7044
GLASS	SATINATO, standard patterned glass
FRAME	KR1
FITTINGS	NOVO, Graphite black

MODELL	3 AURA A834
OBERFLÄCHE	G-TEC® Seidengrau Matt 7044
GLAS	-
ZARGE	KR1
BESCHLAG	NOVO, Graphitschwarz
MODEL	AURA A834
FINISH	G-TEC® Matte Silk Grey 7044
GLASS	-
FRAME	KR1
FITTINGS	NOVO, Graphite black

MODELL	4 AURA A834-LA4S
OBERFLÄCHE	G-TEC® Seidengrau Matt 7044
GLAS	SATINATO, Standard-Ornamentglas
ZARGE	KR1
BESCHLAG	NOVO, Graphitschwarz
MODEL	AURA A834-LA4S
FINISH	G-TEC® Matte Silk Grey 7044
GLASS	SATINATO, standard patterned glass
FRAME	KR1
FITTINGS	NOVO, Graphite black

MODELL	5 AURA A850
OBERFLÄCHE	G-TEC® Seidengrau Matt 7044
GLAS	-
ZARGE	KR1
BESCHLAG	NOVO, Edelstahl Matt
MODEL	AURA A850
FINISH	G-TEC® Matte Silk Grey 7044
GLASS	-
FRAME	KR1
FITTINGS	NOVO, Stainless steel matt

MODELL	6 AURA A851
OBERFLÄCHE	G-TEC® Seidengrau Matt 7044
GLAS	-
ZARGE	KR1
BESCHLAG	NOVO, Edelstahl Matt
MODEL	AURA A851
FINISH	G-TEC® Matte Silk Grey 7044
GLASS	-
FRAME	KR1
FITTINGS	NOVO, Stainless steel matt

MODELL	7 AURA A831
OBERFLÄCHE	G-TEC® Seidengrau Matt 7044
GLAS	-
ZARGE	KR1
BESCHLAG	NOVO, Edelstahl Matt
MODEL	AURA A831
FINISH	G-TEC® Matte Silk Grey 7044
GLASS	-
FRAME	KR1
FITTINGS	NOVO, Stainless steel matt



JETZT TESTEN
Im Online-Türentool „DieTÜR“ von GARANT kombinieren Sie mit einfachen Klicks Ihre individuelle Wunschtür.
TEST NOW
Use GARANT's online door tool "DieTÜR" to create your own custom door in just a few clicks.

Lisene Matt-Schwarz

Lisene Edelstahloptik

MATT

Hochmatte Oberfläche



Anti-Fingerprint



AURA G-TEC® Seidengrau Matt 7044
AURA G-TEC® Matte Silk Grey 7044

Im Stadthaus oder der Altbauwohnung steht die seidige Oberfläche mit ihrem warmen Farbton für ein edles, unaufdringliches Design, in dem man sich sofort zu Hause fühlt.

The silky finish with its warm colour tone immediately makes people feel at home and it is perfect for muted design scenarios in town houses or tastefully renovated apartments.



DESIGNTÜREN
AURA G-TEC® Staubgrau Matt 7037

DESIGN DOORS
AURA G-TEC® Matte Dusty Grey 7037

Auf der staubgrauen Oberfläche sind Matt-Schwarze- oder Edelstahl-Lisenen ein schicker Blickfang – auch im Design-Verbund mit verschiedenen Gläsern.

Matte black or stainless steel pilaster strips look stylish on a matte dusty grey finish, even with various glass panels.



AURA
G-TEC® Staubgrau Matt 7037

Vielseitig auf der ganzen Linie
und individuell kombinierbar.

Across-the-board versatility together
with individual combinability.

Perfekt zu Grautönen und starken Farben.
Perfect with grey shades and bold colours.

QUERSCHNITT | CROSS

KLEINE RUNDKANTE | SMALL ROUNDED EDGE



PREMIUMKANTE | PREMIUM EDGE

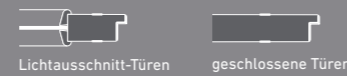

BESCHLAG
MONO

GRAPHITSCHWARZ
GRAPHITE BLACK



BB/PZ/WC



smart2lock

EDELSTAHL MATT
STAINLESS STEEL MATT



BB/PZ/WC



smart2lock



MODELL	1 AURA A830
OBERFLÄCHE	G-TEC® Staubgrau Matt 7037
GLAS	-
ZARGE	KR1
BESCHLAG	MONO, Graphitschwarz
MODEL	AURA A830
FINISH	G-TEC® Matte Dusty Grey 7037
GLASS	-
FRAME	KR1
FITTINGS	MONO, Graphite black

MODELL	2 AURA A830-LA4M
OBERFLÄCHE	G-TEC® Staubgrau Matt 7037
GLAS	SATINATO, Standard-Ornamentglas
ZARGE	KR1
BESCHLAG	MONO, Graphitschwarz
MODEL	AURA A830-LA4M
FINISH	G-TEC® Matte Dusty Grey 7037
GLASS	SATINATO, standard patterned glass
FRAME	KR1
FITTINGS	MONO, Graphite black

MODELL	3 AURA A834
OBERFLÄCHE	G-TEC® Staubgrau Matt 7037
GLAS	-
ZARGE	KR1
BESCHLAG	MONO, Graphitschwarz
MODEL	AURA A834
FINISH	G-TEC® Matte Dusty Grey 7037
GLASS	-
FRAME	KR1
FITTINGS	MONO, Graphite black

MODELL	4 AURA A834-LA4S
OBERFLÄCHE	G-TEC® Staubgrau Matt 7037
GLAS	SATINATO, Standard-Ornamentglas
ZARGE	KR1
BESCHLAG	MONO, Graphitschwarz
MODEL	AURA A834-LA4S
FINISH	G-TEC® Matte Dusty Grey 7037
GLASS	SATINATO, standard patterned glass
FRAME	KR1
FITTINGS	MONO, Graphite black

MODELL	5 AURA A850
OBERFLÄCHE	G-TEC® Staubgrau Matt 7037
GLAS	-
ZARGE	KR1
BESCHLAG	MONO, Edelstahl Matt
MODEL	AURA A850
FINISH	G-TEC® Matte Dusty Grey 7037
GLASS	-
FRAME	KR1
FITTINGS	MONO, Stainless steel matt

MODELL	6 AURA A851
OBERFLÄCHE	G-TEC® Staubgrau Matt 7037
GLAS	-
ZARGE	KR1
BESCHLAG	MONO, Edelstahl Matt
MODEL	AURA A851
FINISH	G-TEC® Matte Dusty Grey 7037
GLASS	-
FRAME	KR1
FITTINGS	MONO, Stainless steel matt

MODELL	7 AURA A831
OBERFLÄCHE	G-TEC® Staubgrau Matt 7037
GLAS	-
ZARGE	KR1
BESCHLAG	MONO, Edelstahl Matt
MODEL	AURA A831
FINISH	G-TEC® Matte Dusty Grey 7037
GLASS	-
FRAME	KR1
FITTINGS	MONO, Stainless steel matt



JETZT TESTEN
Im Online-Türentool „DieTÜR“ von GARANT kombinieren Sie mit einfachen Klicks Ihre individuelle Wunschtür.
TEST NOW
Use GARANT's online door tool 'DieTÜR' to create your own custom door in just a few clicks.

Lisene Matt-Schwarz

Lisene Edelstahloptik

MATT

Hochmatte Oberfläche



Anti-Fingerprint



AURA G-TEC® Staubgrau Matt 7037
AURA G-TEC® Matte Dusty Grey 7037

Die staubgraue Oberfläche entfaltet besondere Stärke im Kontrast mit anderen Farben.
Im modernen Wohnambiente lässt sie sich hervorragend mit Grau- und Holztönen kombinieren.
The dusty grey surface provides a wonderful contrast to other colours.
Combined with grey and wood colours, the effect is beautiful in a modern interior setting.



DESIGNTÜREN
AURA G-TEC® Graphitgrau Matt 7024

DESIGN DOORS
AURA G-TEC® Matte Graphite Grey 7024

Ob modernes Büro oder trendiger Office-Space, Türoberflächen in Graphitgrau sind die Design-Option für die hochwertige, moderne Raumausstattung.

Graphite grey door finishes are the perfect design option for exclusive and modern offices or trendy work environments.



AURA
G-TEC® Graphitgrau Matt 7024

Perfekt zu einer Möblierung
mit Design-Klassikern.

Perfect in conjunction with classic
designer furniture.

Hochwertiger Stil in edlem Design.
Exclusive style meets elegant design.

QUERSCHNITT | CROSS

KLEINE RUNDKANTE | SMALL ROUNDED EDGE



Lichtausschnitt-Türen geschlossene Türen



PREMIUMKANTE | PREMIUM EDGE

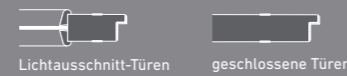

Lichtausschnitt-Türen geschlossene Türen



BESCHLAG
QUATTRA INLAY

GRAPHITSCHWARZ
GRAPHITE BLACK



BB/PZ/WC



smart2lock

EDELSTAHL MATT
STAINLESS STEEL MATT



BB/PZ/WC



smart2lock



MODELL 1 AURA A830
OBERFLÄCHE G-TEC® Graphitgrau Matt 7024
GLAS -
ZARGE KR1
BESCHLAG QUATTRA INLAY, Graphitschwarz
MODEL AURA A830
FINISH G-TEC® Matte Graphite Grey 7024
GLASS -
FRAME KR1
FITTINGS QUATTRA INLAY, Graphite black

MODELL 2 AURA A830-LA4M
OBERFLÄCHE G-TEC® Graphitgrau Matt 7024
GLAS SATINATO, Standard-Ornamentglas
ZARGE KR1
BESCHLAG QUATTRA INLAY, Graphitschwarz
MODEL AURA A830-LA4M
FINISH G-TEC® Matte Graphite Grey 7024
GLASS SATINATO, standard patterned glass
FRAME KR1
FITTINGS QUATTRA INLAY, Graphite black

MODELL 3 AURA A834
OBERFLÄCHE G-TEC® Graphitgrau Matt 7024
GLAS -
ZARGE KR1
BESCHLAG QUATTRA INLAY, Graphitschwarz
MODEL AURA A834
FINISH G-TEC® Matte Graphite Grey 7024
GLASS -
FRAME KR1
FITTINGS QUATTRA INLAY, Graphite black

MODELL 4 AURA A834-LA4S
OBERFLÄCHE G-TEC® Graphitgrau Matt 7024
GLAS SATINATO, Standard-Ornamentglas
ZARGE KR1
BESCHLAG QUATTRA INLAY, Graphitschwarz
MODEL AURA A834-LA4S
FINISH G-TEC® Matte Graphite Grey 7024
GLASS SATINATO, standard patterned glass
FRAME KR1
FITTINGS QUATTRA INLAY, Graphite black

MODELL 5 AURA A850
OBERFLÄCHE G-TEC® Graphitgrau Matt 7024
GLAS -
ZARGE KR1
BESCHLAG QUATTRA INLAY, Edelstahloptik Matt
MODEL AURA A850
FINISH G-TEC® Matte Graphite Grey 7024
GLASS -
FRAME KR1
FITTINGS QUATTRA INLAY, Matt stainless steel look

MODELL 6 AURA A851
OBERFLÄCHE G-TEC® Graphitgrau Matt 7024
GLAS -
ZARGE KR1
BESCHLAG QUATTRA INLAY, Edelstahloptik Matt
MODEL AURA A851
FINISH G-TEC® Matte Graphite Grey 7024
GLASS -
FRAME KR1
FITTINGS QUATTRA INLAY, Matt stainless steel look

MODELL 7 AURA A831
OBERFLÄCHE G-TEC® Graphitgrau Matt 7024
GLAS -
ZARGE KR1
BESCHLAG QUATTRA INLAY, Edelstahloptik Matt
MODEL AURA A831
FINISH G-TEC® Matte Graphite Grey 7024
GLASS -
FRAME KR1
FITTINGS QUATTRA INLAY, Matt stainless steel look



JETZT TESTEN
Im Online-Türentool „DieTÜR“ von GARANT kombinieren Sie mit einfachen Klicks Ihre individuelle Wunschtür.
TEST NOW
Use GARANT's online door tool "DieTÜR" to create your own custom door in just a few clicks.

Lisene Matt-Schwarz

Lisene Edelhloptik

MATT

Hochmatte Oberfläche



Anti-Fingerprint



AURA G-TEC® Graphitgrau Matt 7024
AURA G-TEC® Matte Graphite Grey 7024

Die matte Oberfläche punktet im modernen Office-Ambiente durch edles Graphitgrau. Fingerabdrücke haben hier keine Chance.
The matte finish in elegant graphite grey looks fabulous in a modern office environment. It is also a completely finger print-free zone.



DESIGNTÜREN
AURA G-TEC® Schwarz Matt 9005

DESIGN DOORS
AURA G-TEC® Matte Black 9005

Ein Star im Interior Design für zeitloses, hochwertiges Look & Feel
im trendorientierten Wohn- oder Officebereich.

An interior design star with a timelessly elegant look & feel
for trendy homes and offices



AURA
G-TEC® Schwarz Matt 9005

Edles Entree für das vollendete Raumdesign.

An elegant entrée to perfect interior design.

Für den gehobenen Auftritt in Kombination mit Einrichtungsklassikern.
For an upmarket look in combination with classical furnishings.

QUERSCHNITT | CROSS

KLEINE RUNDKANTE | SMALL ROUNDED EDGE



PREMIUMKANTE | PREMIUM EDGE

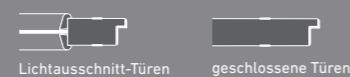

BESCHLAG
QUATTRA INLAY

GRAPHITSCHWARZ
GRAPHITE BLACK



BB/PZ/WC



smart2lock

EDELSTAHL MATT
STAINLESS STEEL MATT



BB/PZ/WC



smart2lock



MODELL 1 AURA A830
OBERFLÄCHE G-TEC® Schwarz Matt 9005
GLAS -
ZARGE KR1
BESCHLAG QUATTRA INLAY, Graphitschwarz
MODEL AURA A830
FINISH G-TEC® Matte Black 9005
GLASS -
FRAME KR1
FITTINGS QUATTRA INLAY, Graphite black

MODELL 2 AURA A830-LA4M
OBERFLÄCHE G-TEC® Schwarz Matt 9005
GLAS SATINATO, Standard-Ornamentglas
ZARGE KR1
BESCHLAG QUATTRA INLAY, Graphitschwarz
MODEL AURA A830-LA4M
FINISH G-TEC® Matte Black 9005
GLASS SATINATO, standard patterned glass
FRAME KR1
FITTINGS QUATTRA INLAY, Graphite black

MODELL 3 AURA A834
OBERFLÄCHE G-TEC® Schwarz Matt 9005
GLAS -
ZARGE KR1
BESCHLAG QUATTRA INLAY, Graphitschwarz
MODEL AURA A834
FINISH G-TEC® Matte Black 9005
GLASS -
FRAME KR1
FITTINGS QUATTRA INLAY, Graphite black

MODELL 4 AURA A834-LA4S
OBERFLÄCHE G-TEC® Schwarz Matt 9005
GLAS SATINATO, Standard-Ornamentglas
ZARGE KR1
BESCHLAG QUATTRA INLAY, Graphitschwarz
MODEL AURA A834-LA4S
FINISH G-TEC® Matte Black 9005
GLASS SATINATO, standard patterned glass
FRAME KR1
FITTINGS QUATTRA INLAY, Graphite black

MODELL 5 AURA A850
OBERFLÄCHE G-TEC® Schwarz Matt 9005
GLAS -
ZARGE KR1
BESCHLAG QUATTRA INLAY, Edelhstahloptik Matt
MODEL AURA A850
FINISH G-TEC® Matte Black 9005
GLASS -
FRAME KR1
FITTINGS QUATTRA INLAY, Matt stainless steel look

MODELL 6 AURA A851
OBERFLÄCHE G-TEC® Schwarz Matt 9005
GLAS -
ZARGE KR1
BESCHLAG QUATTRA INLAY, Edelhstahloptik Matt
MODEL AURA A851
FINISH G-TEC® Matte Black 9005
GLASS -
FRAME KR1
FITTINGS QUATTRA INLAY, Matt stainless steel look

MODELL 7 AURA A831
OBERFLÄCHE G-TEC® Schwarz Matt 9005
GLAS -
ZARGE KR1
BESCHLAG QUATTRA INLAY, Edelhstahloptik Matt
MODEL AURA A831
FINISH G-TEC® Matte Black 9005
GLASS -
FRAME KR1
FITTINGS QUATTRA INLAY, Matt stainless steel look



JETZT TESTEN
Im Online-Türentool „DieTÜR“ von GARANT kombinieren Sie mit einfachen Klicks Ihre individuelle Wunschtür.
TEST NOW
Use GARANT's online door tool "DieTÜR" to create your own custom door in just a few clicks.

Lisene Matt-Schwarz

Lisene Edelstahloptik



Hochmatte Oberfläche



Anti-Fingerprint



AURA G-TEC® Schwarz Matt 9005

AURA G-TEC® Matte Black 9005

Die perfekte Ausstattung im Designkonzept: silberglänzende Lisenen und Lichtausschnitte kombiniert mit schwarzen Oberflächen.

The perfect look for the design concept: shiny silver pilaster strips and glass panels in combination with black finishes.

Gesamtübersicht DESIGNTÜREN-Programm

Overview of the DESIGN DOOR range

AURA | AURA

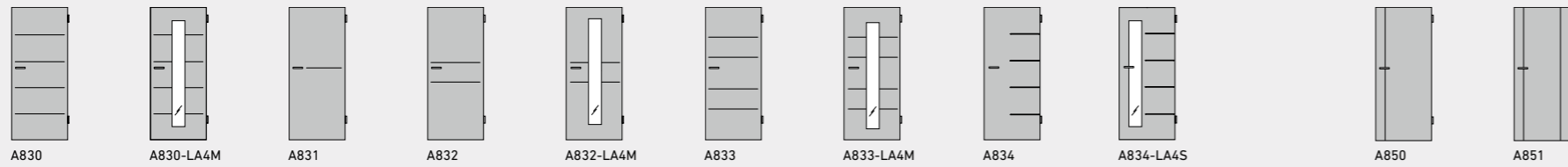

OBERFLÄCHEN | FINISHES



TÜRKANTEN | EDGES



GLÄSER | GLASS PANELS

MODERNE ORNAMENTGLÄSER | MODERN PATTERNED GLASS PANELS

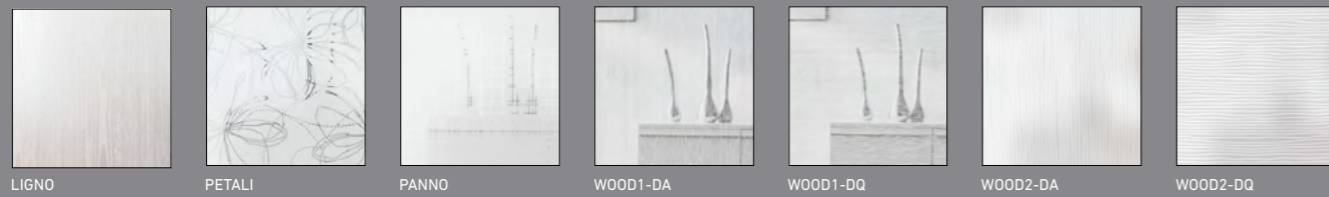

DESIGNGLÄSER – SIEBDRUCK-VEREDELUNG | DESIGN GLASS PANELS – SCREEN PRINTED DÉCOR

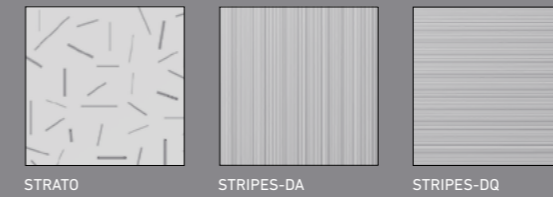

KLASSISCHE ORNAMENTGLÄSER | CLASSIC PATTERNED GLASS PANELS



TOP-BESCHLÄGE | TOP-FERRURE

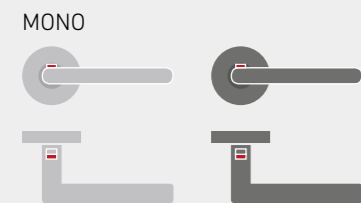

WÄHLBAR IN EDELSTAHL MATT ODER GRAPHITSCHWARZ
AVAILABLE IN STAINLESS STEEL MATT OR GRAPHITE BLACK

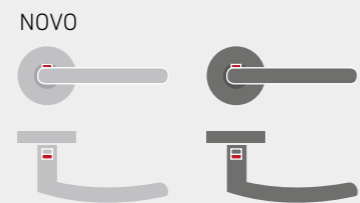

WÄHLBAR IN EDELSTAHL MATT ODER GRAPHITSCHWARZ
AVAILABLE IN STAINLESS STEEL MATT OR GRAPHITE BLACK

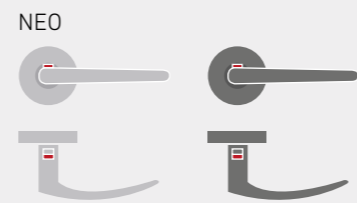

WÄHLBAR IN EDELSTAHL MATT ODER GRAPHITSCHWARZ
AVAILABLE IN STAINLESS STEEL MATT OR GRAPHITE BLACK

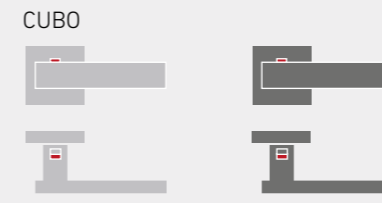

WÄHLBAR IN EDELSTAHL MATT ODER GRAPHITSCHWARZ
AVAILABLE IN STAINLESS STEEL MATT OR GRAPHITE BLACK

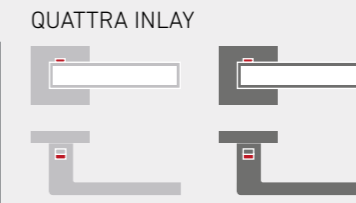

WÄHLBAR IN EDELSTAHOPTIK MATT ODER GRAPHITSCHWARZ
AVAILABLE IN MATT STAINLESS STEEL LOOK OR GRAPHITE BLACK

INLAYS | INLAYS



Elemente

Elements

Beim Thema Türen sind wir in unserem Element und können Ihnen mit Sicherheit immer die richtigen Türelemente bieten. Unsere durchdachten Lösungen ermöglichen Ihnen die Umsetzung Ihrer individuellen Raumkonzepte.

We're in our element when it comes to the subject of doors, and we guarantee we can always provide you with the perfect door elements. Our clever solutions enable you to realise your personal interior design concepts.



WINDFANGELEMENTE UND SCHIEBETÜRLÖSUNGEN



DOPPELTÜREN (2-FLG. TÜREN)



Windfangelemente und Schiebetürlösungen Draught-stop elements and sliding doors



SCHIEBETÜRBESCHLAG LINE

Das schlanke Schiebetürsystem im Edelstahl-Design für Holz- und Ganzglastüren. LINE ist wahlweise auch mit Einzugsdämpfung (beidseitig) lieferbar.

LINE SLIDING DOOR FITTING

The streamlined sliding door system in a stainless steel design for wood and all-glass doors is also available with an optional soft close function (both sides).



SCHIEBETÜRBESCHLAG BASIC – AUSFÜHRUNG „VOR DER WAND LAUFEND“

Die gehobene Holzklasse, unser BASIC-Schiebetürbeschlag für Holz- und Ganzglastüren. Öffnen Sie Türen auf die klassische Art. BASIC ist wahlweise auch mit Einzugsdämpfung (ein- oder beidseitig) lieferbar.

BASIC SLIDING DOOR FITTING – ‘FRONT OF WALL’ VERSION

Our BASIC sliding door fittings for wood and all-glass doors are premium hardware. Open the doors in the conventional way. BASIC is also available with an optional soft close function (one or both sides).

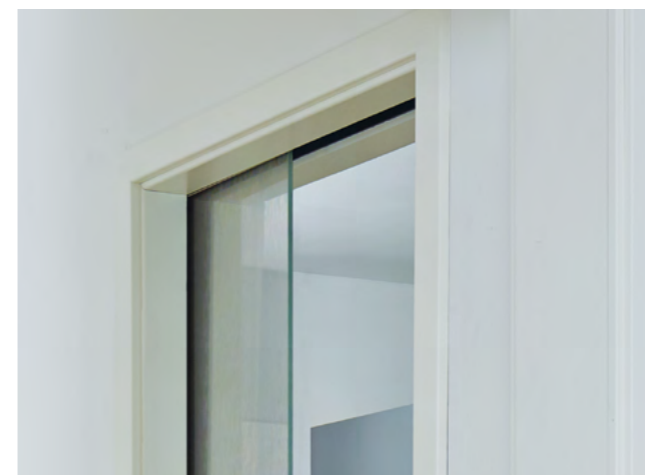

SCHIEBETÜRBESCHLAG BASIC – AUSFÜHRUNG „IN DER WAND LAUFEND“

Innenlaufende Schiebetüren mit dem BASIC-Schiebetürbeschlag – egal ob als Holz- oder Ganzglastüren – sind die ideale Lösung, wenn es für normale Drehtüren in den verbundenen Räumen keinen Öffnungs- und Bewegungsraum gibt.

BASIC SLIDING DOOR FITTINGS – ‘IN-WALL’ VERSION

In-wall sliding doors – both wood and glass models – with BASIC sliding door fittings are the ideal solution when there is no space for conventionally opening doors in connected rooms.



Windfangelemente und Schiebetürlösungen

Schiebetürbeschlag LINE

LINE sliding door fittings

Platzsparendes Design auch für kleine Räume.
Space-saving design for small rooms.



SCHIEBETÜRBESCHLAG LINE

Das schlanke Schiebetürsystem im Edelstahl-Design für Holz- und Ganzglastüren. LINE ist wahlweise auch mit Einzugsdämpfung (beidseitig) lieferbar.

LINE SLIDING DOOR FITTINGS

The streamlined sliding door system in a stainless steel design for wood and all-glass doors is also available with an optional soft close function (both sides).

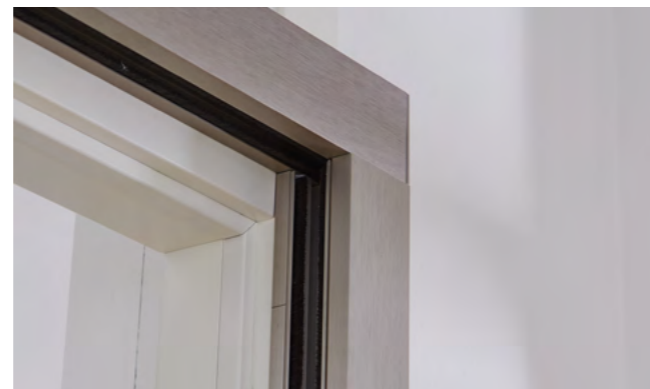

LINE mit Anschlagkasten



Befestigung einer Holztür im Schiebetürbeschlag LINE

LINE-Schiebetürbeschlag mit Inlay

LINE sliding door fitting with inlay

VIDEO Windfangelemente und Schiebetürlösungen
Draught-stop elements and sliding doors

[KLICK](#)



In diesen Oberflächen erhältlich | Available in these finishes



WEISS 9010
WHITE 9010



WEISS 9016
WHITE 9016



SCHWARZ 9005
BLACK 9005



Befestigung einer Ganzglastür im Schiebetürbeschlag LINE



LINE ohne Anschlagkasten



VERDOPPELN SIE IHRE MÖGLICHKEITEN

Mit unseren 2-flügeligen Türen sorgen Sie für mehr Großzügigkeit, Offenheit und Licht. So kommen Ihre Räume ganz groß heraus.

DOUBLE YOUR POSSIBILITIES

With our double-leaf doors you get more space, openness and light. They help you to maximise your room space.



NORMTÜR NT-DA, 2-flügelig, G-TEC® Weißlack Matt 9016



NORMTÜR NT-LA4M-DA 2-flügelig, Verglasung PETALI, G-TEC® Staubgrau Matt 7037



A832-LA4M 2-flügelig, Verglasung STRIPES DQ, G-TEC® Seidengrau Matt 7044



Doppeltüren (2-flg.) | Double-leaf doors

Großzügigkeit mal 2 | Twice the size

Technische Details

Technical details

ENTDECKEN SIE UNSERE TÜRENDETAILS AUF EINEN BLICK

Eine Übersicht über Glasprogramm, Beschläge, Zargen und spezielle Funktionen.

ALL THE DETAILS ABOUT OUR DOORS AT A GLANCE

An overview of the glass range, fittings, frames and special functions.

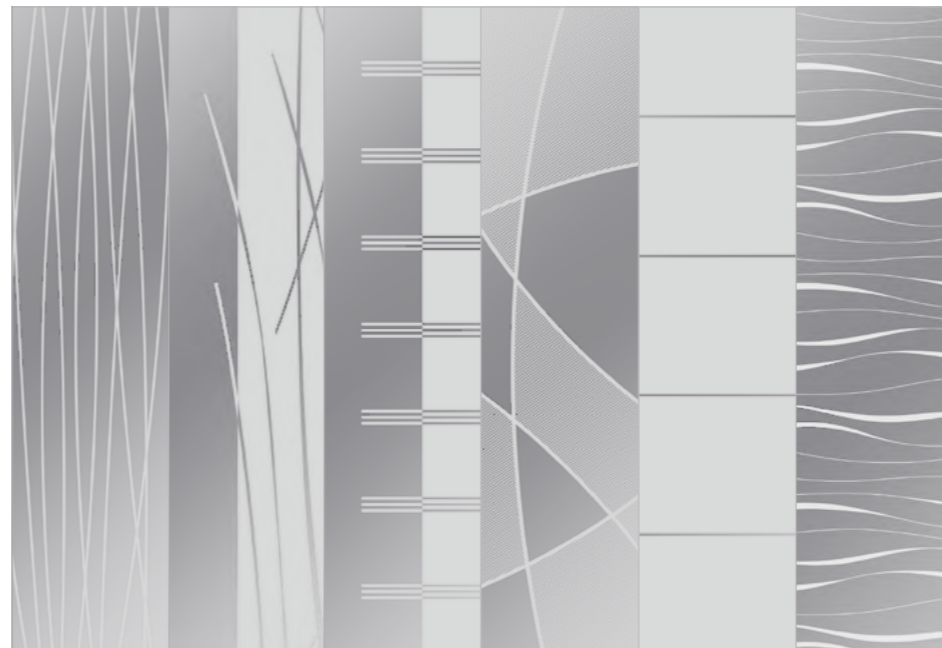

GARANT-DESIGNVERBUND
Ornamentgläser als Ganzglastür
und Lichtausschnittgläser erhältlich.

GARANT DESIGN COMPOSITION
Patterned glass is available for
doors and door panels.

Ornamentglas für Ganzglastüren

Patterned glass for all-glass doors

Moderne Ganzglastüren für raffinierte Lichtblicke.

Modern all-glass doors are a clever way to make rooms lighter.

DESIGN-ORNAMENTGLAS | DESIGN PATTERNED GLASS



WOOD1-DA



WOOD1-DQ



WOOD2-DA



WOOD2-DQ



LIGNO



PETALI



PANNO

STANDARD-ORNAMENTGLAS | STANDARD PATTERNED GLASS



CHINCHILLA WEISS
CHINCHILLA WHITE



MASTERLIGNÈ



MASTERPOINT



MASTERCARRÉ



KLARGLAS
TRANSPARENT GLASS



SATINATO

GARANT-DESIGNVERBUND
Ornamentgläser als Ganzglastür
und Lichtausschnittgläser erhältlich.

GARANT DESIGN COMPOSITION
Patterned glass is available for
doors and door panels.

Ornamentglas für Lichtausschnitt-Türen

Patterned glass for doors with panels

Wählen Sie Transparenz.
Choose transparency.

DESIGN-ORNAMENTGLAS | DESIGN PATTERNED GLASS



WOOD1-DA



WOOD1-DQ

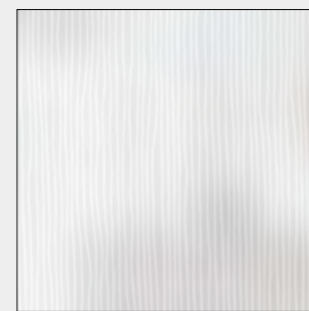

WOOD2-DA



WOOD2-DQ

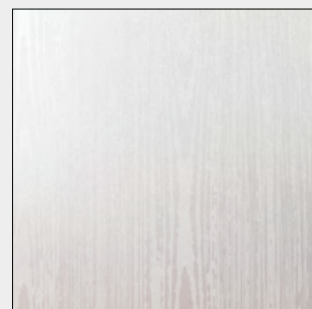

LIGNO

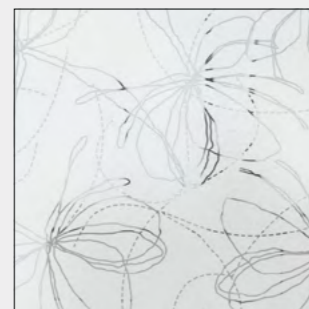

PETALI

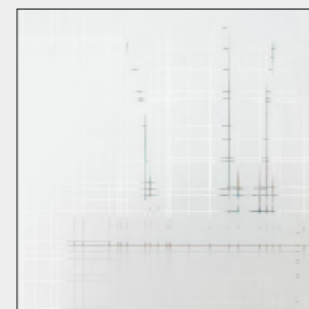

PANNO

STANDARD-ORNAMENTGLAS | STANDARD PATTERNED GLASS

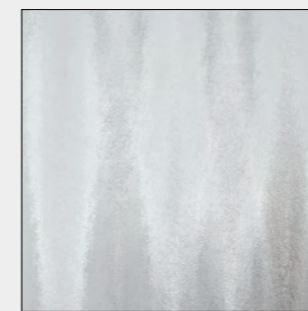

CHINCHILLA WEISS
CHINCHILLA WHITE

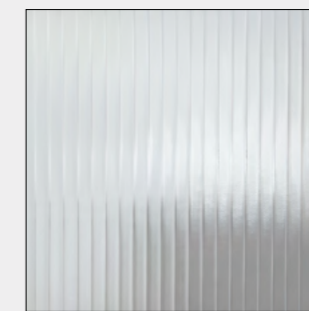

MASTERLIGNÈ



MASTERPOINT



MASTERCARRÉ

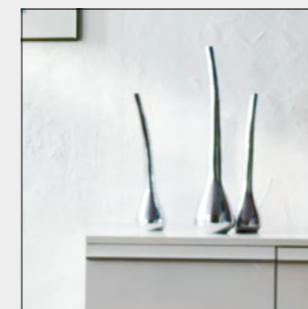

KLARGLAS
TRANSPARENT GLASS



SATINATO

Designglas für Ganzglastüren

Design patterned glass for all-glass doors

Transparenz mit edlem Charakter.
Elegant transparency.

GARANT-DESIGNVERBUND
Designglas motive als Ganzglastür
und Lichtausschnittgläser erhältlich.

GARANT DESIGN COMPOSITION
Design glass motifs are available
for all-glass doors and door panels.

SIEBDRUCK-VEREDELUNG | SCREEN PRINTED DÉCOR



LINEUM



LINUS



SEVENTY



BAMBUS



FREE



LIPSO



DESIGN R11.1



DESIGN R11.2



DESIGN R14.1



DESIGN R18.1



DESIGN R110.1



ACCORDIA



DESIGN R111.1

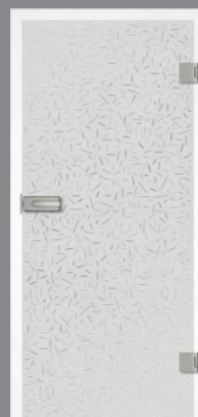

STRATO



STRIPES DA



STRIPES DQ

LASER-VEREDELUNG | LASER DÉCOR



ARPA



PALLA



FIORE



SAGI

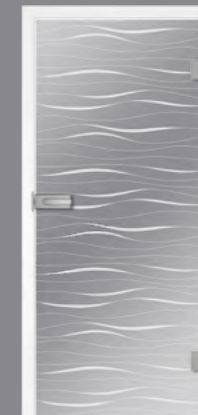

ONDA 1



ONDA 2



MOTUS



FLORA 1



FLORA 2



CENTRO



LINEA 1

GARANT-DESIGNVERBUND
 Designglas motive als Ganzglastür
 und Lichtausschnittgläser erhältlich.

GARANT DESIGN COMPOSITION
 Design glass motifs are available
 for all-glass doors and door panels.

Designglas für Lichtausschnitt-Türen

Design patterned glass for doors with panels

Weil ich einzigartigen Durchblick will.
 Because I want unique vision.

SIEBDRUCK-VEREDELUNG | SCREEN PRINTED DÉCOR



LINEUM



LINUS



SEVENTY



BAMBUS



FREE



LIPSO

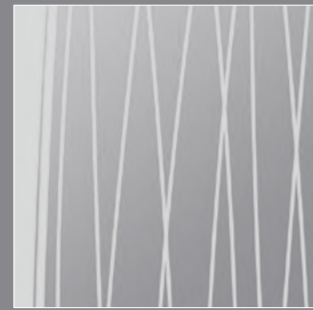

ACCORDIA



LINEA 1

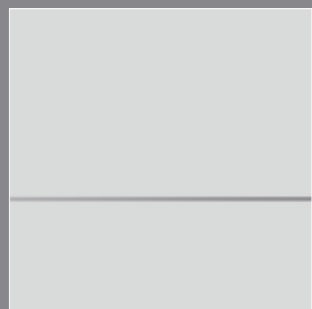

DESIGN RI1.1

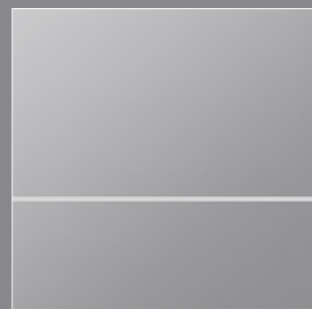

DESIGN RI1.2

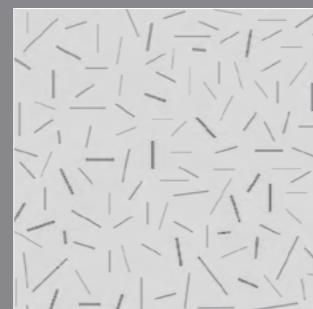

STRATO



STRIPES DA/DQ

LASER-VEREDELUNG | LASER DÉCOR



ARPA



PALLA



FIORE



SAGI

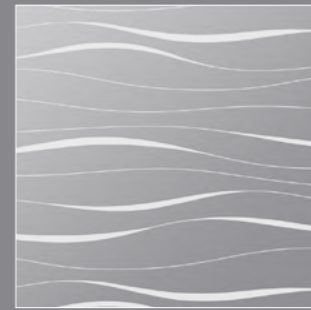

ONDA 1

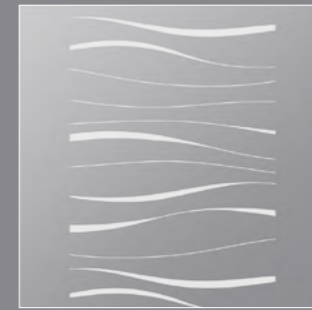

ONDA 2



MOTUS



CENTRO



FLORA 1



FLORA 2

TOP

STYLE

PREMIUM

Beschlagsvielfalt in Stil und System Diverse fitting styles and systems

TÜRGRIFFE UND ZUBEHÖR FÜR ALLE ANWENDUNGEN

Türbeschläge sind ein prägendes Stilelement der Tür und unterstreichen die architektonische Note des Raums. Unser umfassendes Sortiment bietet eine Vielzahl an Designs und für jede Anforderung die passende Lösung: vom Türgriff, über das Glastürschloss bis hin zu passenden Bändern.

DOOR HANDLES AND ACCESSORIES FOR ALL APPLICATIONS

Door handles are distinctive elements of the door. They make a style statement and underline the room's architectural tone. We offer a comprehensive range of designs and the perfect solutions for all requirements: from door handles to glass door locks and matching hinges.



TOP MONO











GARANT

Griffwerk

TOP

MONO

 <p>MONO BB Schnellmontagetechnik Graphitschwarz Quick mounting mechanism Graphite black</p>	 <p>MONO BB Schnellmontagetechnik Edelstahl matt Quick mounting mechanism Matte stainless steel</p>
 <p>smart2lock by GRIFFWERK</p> <p>MONO Schnellmontagetechnik Graphitschwarz Quick mounting mechanism Graphite black</p>	 <p>smart2lock by GRIFFWERK</p> <p>MONO Schnellmontagetechnik Edelstahl matt Quick mounting mechanism Matte stainless steel</p>
 <p>MONO GGT Glastürbeschlag PURISTO S Graphitschwarz Glass door fittings Graphite black</p>	 <p>MONO GGT Glastürbeschlag PURISTO S Edelstahl matt Glass door fittings Matte stainless steel</p>
 <p>smart2lock by GRIFFWERK</p> <p>MONO GGT Glastürbeschlag PURISTO S Graphitschwarz Glass door fittings Graphite black</p>	 <p>smart2lock by GRIFFWERK</p> <p>MONO GGT Glastürbeschlag PURISTO S Edelstahl matt Glass door fittings Matte stainless steel</p>

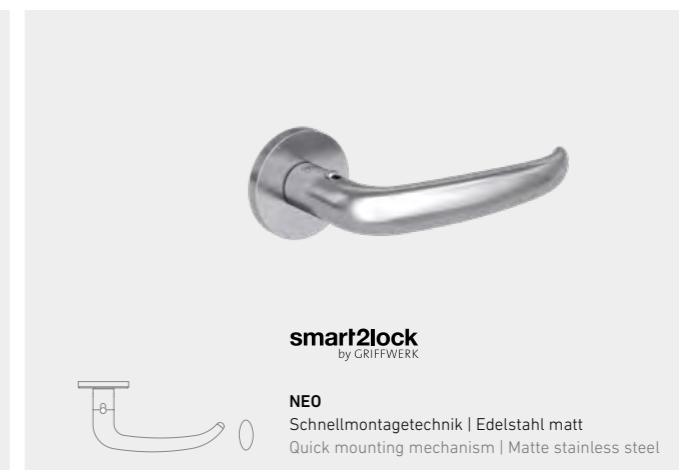
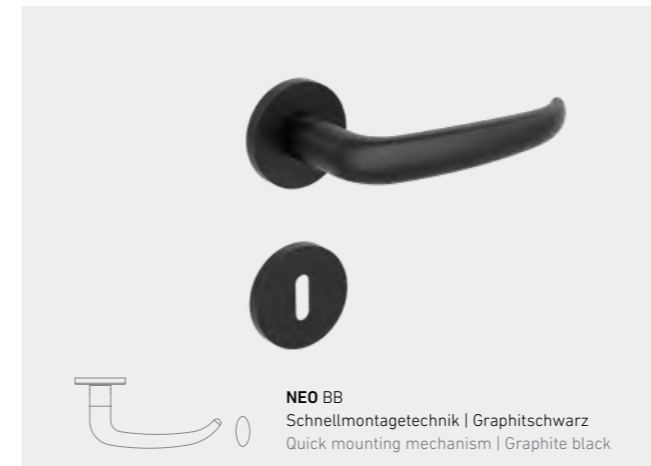
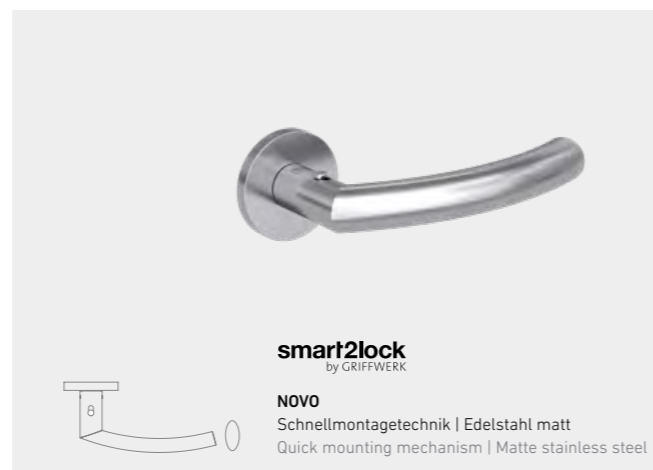
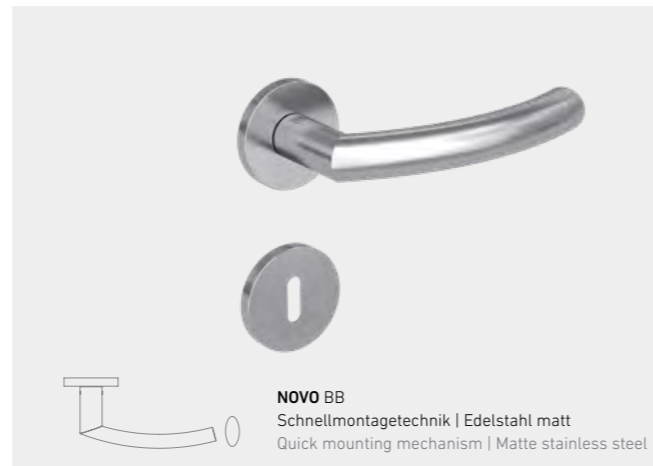
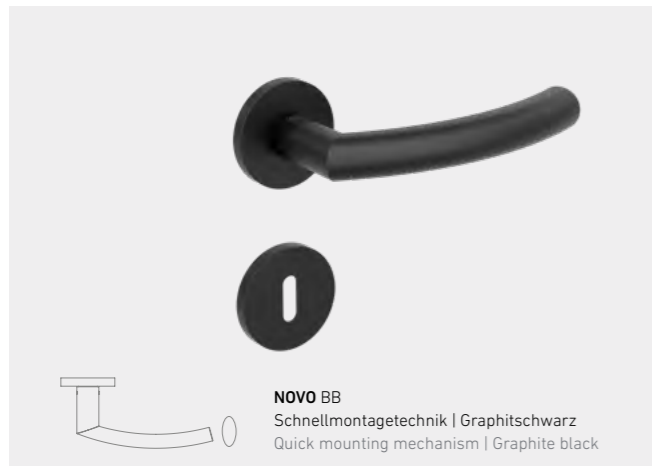

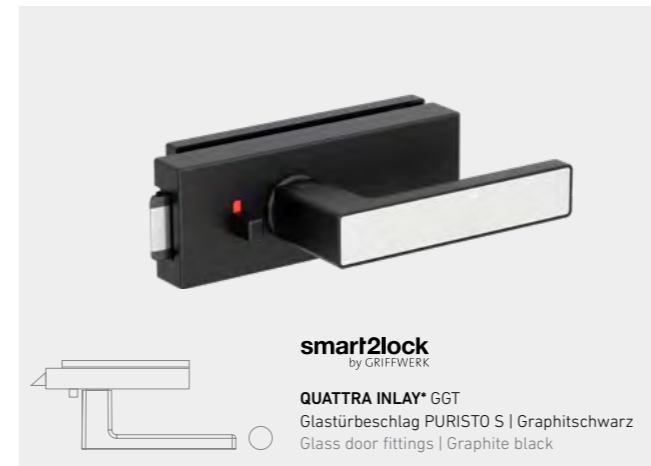
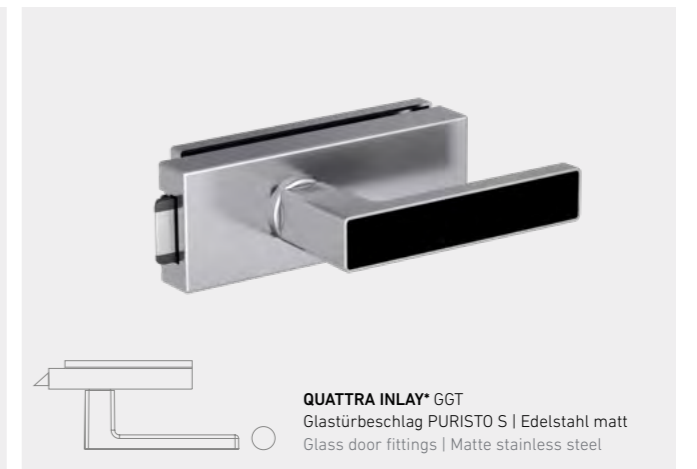
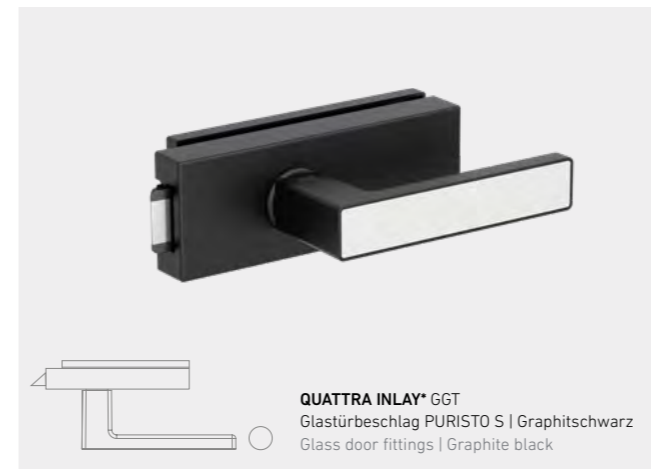
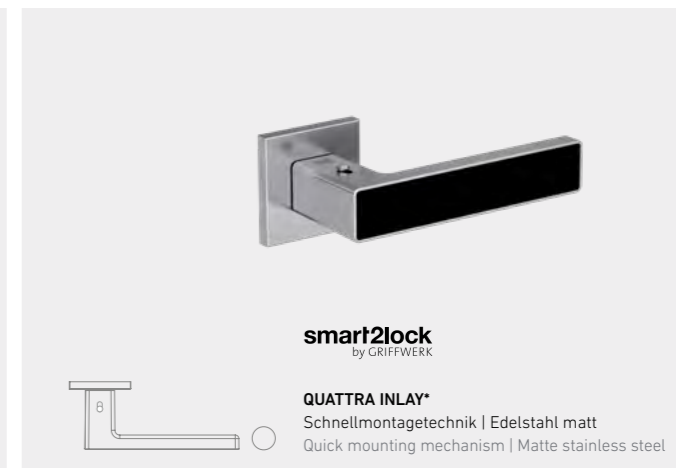
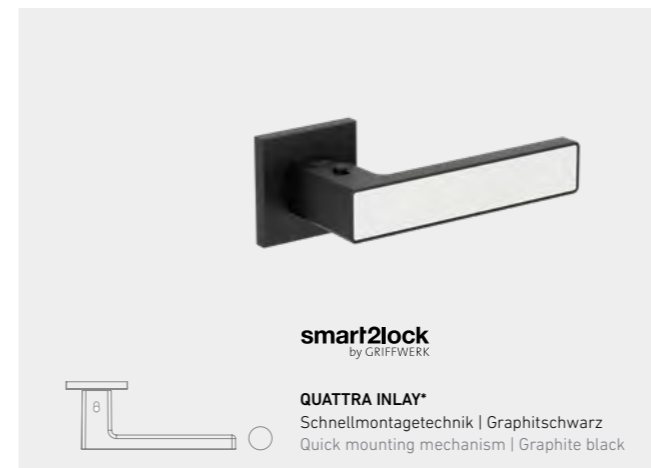
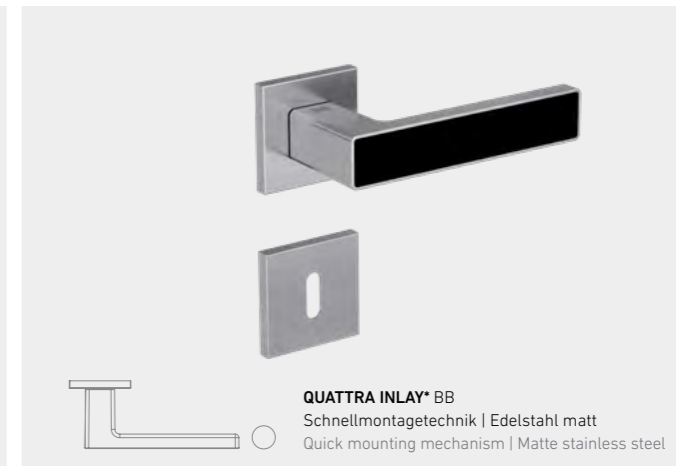
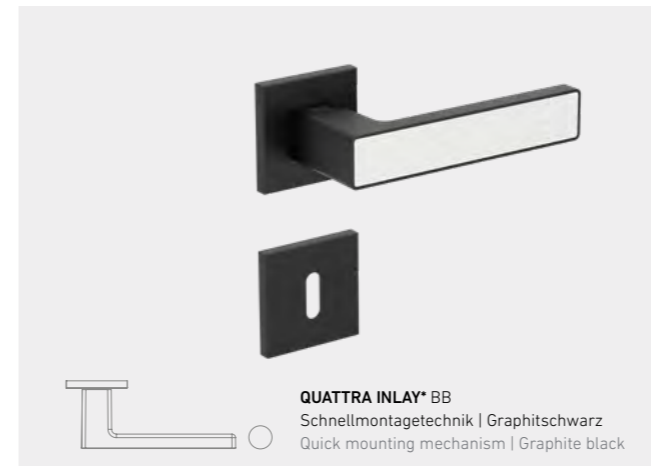
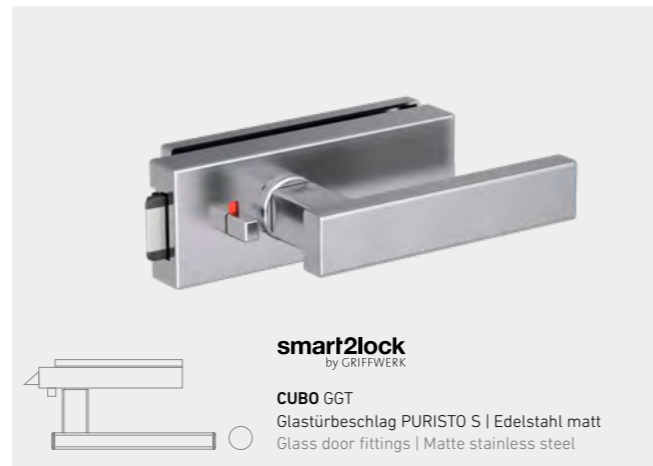
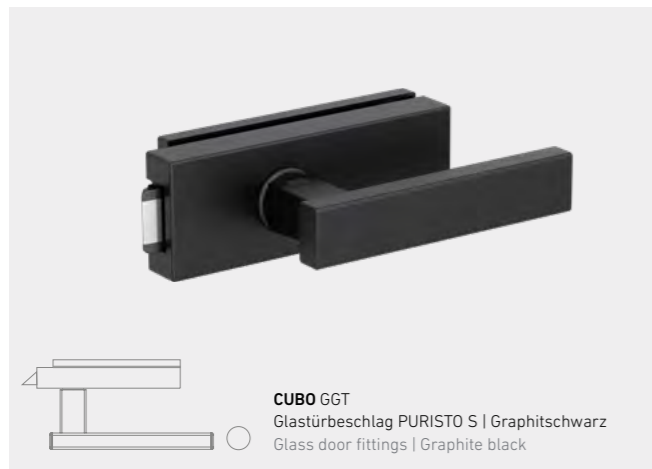
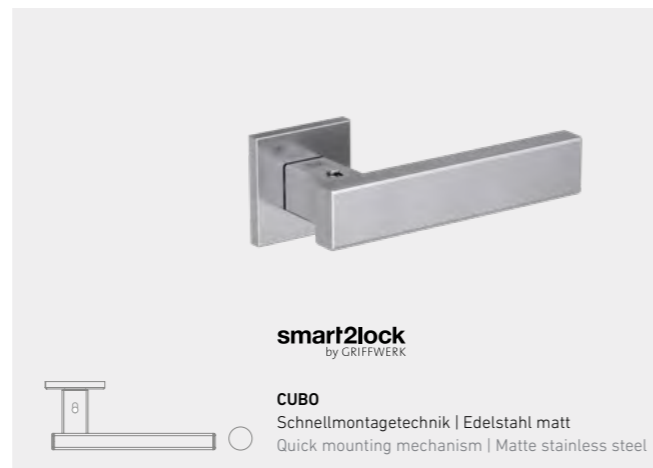
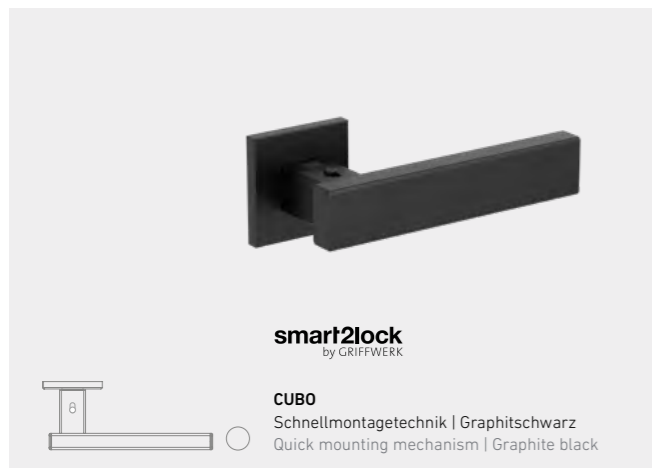
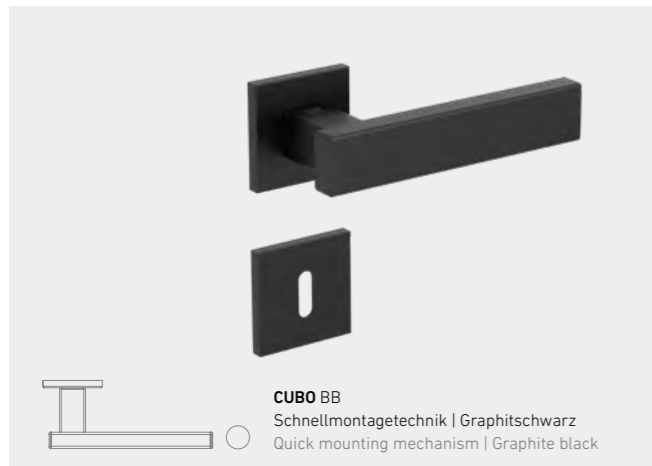

*Inlays in allen G-TEC®-Oberflächen erhältlich *Inlays available in all G-TEC® surfaces

MONO

STANDARD-ROSETTE
STANDARD ROSETTE



BB-Schloss Rosette
BB lock with magnetic rosette

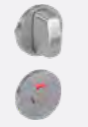

WC-Schloss
WC lock



PZ-Schloss
PZ lock



Schutzbeschlag EH, RD
EH, RD security lock plate

BÄNDER SCHLÖSSER
HINGES LOCKS



2-teiliges Holztürenband
2-part wooden door hinge



3-teiliges Holztürenband
3-part wooden door hinge



BB/PZ Schloss
Schlossstulp
BB/PC lock
lock neck



Magnetschloß lang
Schlossstulp
Long magnetic lock
lock neck



Schließblech lang
Long locking plate

MONO

STANDARD
STANDARD



UV-Schloss
UV lock



PZ-Schloss
PZ lock



smart2lock
by GRIFFWERK

NOVO

STANDARD
STANDARD



UV-Schloss
UV lock



PZ-Schloss
PZ lock



smart2lock
by GRIFFWERK

NEO

STANDARD
STANDARD



UV-Schloss
UV lock



PZ-Schloss
PZ lock



smart2lock
by GRIFFWERK

CUBO

STANDARD
STANDARD



UV-Schloss
UV lock



PZ-Schloss
PZ lock



smart2lock
by GRIFFWERK

QUATTRA INLAY

STANDARD-ROSETTE
STANDARD ROSETTE



BB-Schloss Rosette
BB lock with magnetic rosette



WC-Schloss
WC lock



PZ-Schloss
PZ lock



Schutzbeschlag EH, RD
EH, RD security lock plate

BÄNDER ZUBEHÖR
HINGES ACCESSORIES



Gegenkasten (2-flg.)
Strike box (2-part)



Band (3-tlg.)
Hinge (3-part)



Schließblech kurz
Short locking plate

MONO

STANDARD-ROSETTE
STANDARD ROSETTE



BB-Schloss Rosette
BB lock with magnetic rosette

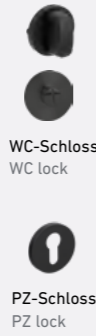

WC-Schloss
WC lock
PZ-Schloss
PZ lock



Schutzbeschlag EH, RD
EH, RD security lock plate

PZW-Knopf
PZW knob

BÄNDER SCHLÖSSER
HINGES LOCKS



2-teiliges Holztürenband
2-part wooden door hinge



3-teiliges Holztürenband
3-part wooden door hinge



BB/PC Schloss
Schlossstulp Schwarz
BB/PC lock
Graphite black lock neck



Magnetschloß lang
Schlossstulp Schwarz
Long magnetic lock
Graphite black lock neck



Schließblech lang
Long locking plate

MONO

STANDARD
STANDARD



UV-Schloss
UV lock



PZ-Schloss
PZ lock



smart2lock
by GRIFFWERK

NOVO

STANDARD
STANDARD



UV-Schloss
UV lock



PZ-Schloss
PZ lock



smart2lock
by GRIFFWERK

NEO

STANDARD
STANDARD



UV-Schloss
UV lock



PZ-Schloss
PZ lock



smart2lock
by GRIFFWERK

CUBO

STANDARD
STANDARD



UV-Schloss
UV lock



PZ-Schloss
PZ lock



smart2lock
by GRIFFWERK

QUATTRA INLAY

STANDARD-ROSETTE
STANDARD ROSETTE



BB-Schloss Rosette
BB lock with magnetic rosette



WC-Schloss
WC lock
PZ-Schloss
PZ lock



Schutzbeschlag EH, RD
EH, RD security lock plate

PZW-Knopf
PZW knob

BÄNDER ZUBEHÖR
HINGES ACCESSORIES



Gegenkasten (2-flg.)
Strike box (2-part)



Band (3-tlg.)
Hinge (3-part)



Schließblech kurz
Short locking plate

Besondere Akzente setzen Make a big statement

DESIGNTÜRGRIFFE, DIE IN STIL UND HAPTİK ÜBERZEUGEN

Außergewöhnliches Design und mehr Komfort: Die Tür erfährt durch unsere Designtürgriffe eine zusätzliche Aufwertung. Zudem bieten die hochwertigen Oberflächen eine angenehme Haptik – ein Luxus, den sie täglich erleben können.

DESIGNER DOOR HANDLES WITH IMPRESSIVE STYLE AND HAPTICS

Exceptional design and extra convenience: Our designer door handles make the door look even more exclusive. Their premium finishes also enhance the haptics for luxury you can experience every day.



**Griff
werk**



LUCIA PROFESSIONAL
Schraubtechnik | Graphitschwarz und Edelstahl matt
Rund- oder Quadratrossette
Screw mechanism | graphite black and matte stainless
steel, round or square rosette



LUCIA PIATTA S
Flachrossette | Graphitschwarz und Edelstahl matt
Rund- oder Quadratrossette
Flat rosette | graphite black and matte stainless steel
Round or square rosette



TRI 134
Schraubtechnik | Graphitschwarz und Edelstahl matt
Rund- oder Quadratrossette
Screw mechanism | graphite black and matte stainless
steel, round or square rosette



TRI 134 PIATTA S
Flachrossette | Graphitschwarz und Edelstahl matt
Rundrossette
Flat rosette | graphite black and matte stainless
steel, round or square rosette

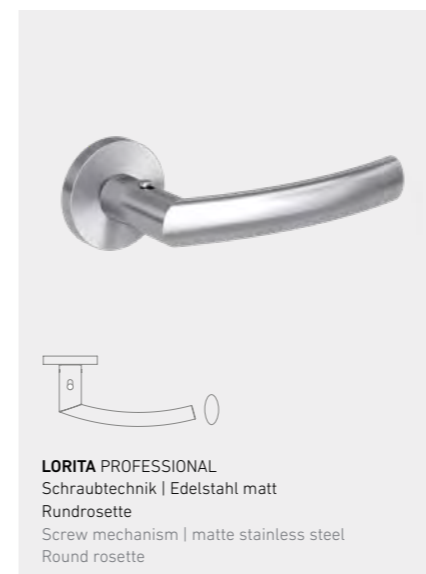

LORITA PROFESSIONAL
Schraubtechnik | Edelstahl matt
Rundrossette
Screw mechanism | matte stainless steel
Round rosette

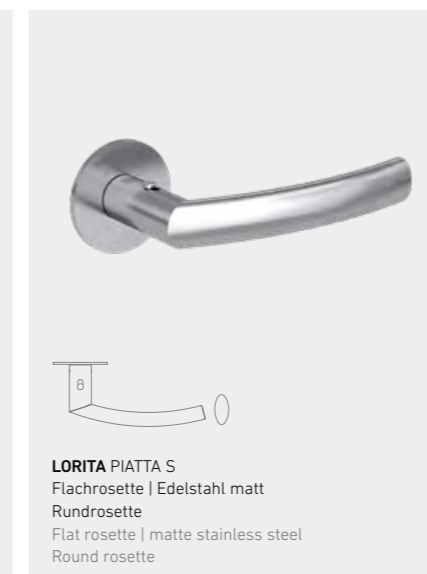

LORITA PIATTA S
Flachrossette | Edelstahl matt
Rundrossette
Flat rosette | matte stainless steel
Round rosette



AVUS PIATTA S
Flachrossette | Graphitschwarz und Kaschmirgrau,
Rundrossette
Flat rosette | graphite black and cashmere grey,
round rosette

Türgriffe der Extraklasse

Extra-special door handles

ONE – DESIGNKONZEPT OHNE ROSETTEN

Maximale Reduktion, dafür steht ONE: Auf Rosetten wird bei dieser Türgriffserie völlig verzichtet. Der Griff sitzt direkt auf dem Türblatt auf und passt dennoch auf Türen mit Standardschlössern. Bei der Version mit Schließmechanik wurde diese in den Griffhals integriert. Ein Griffdesign für höchste Ansprüche.

ONE – NO-ROSETTE DESIGN

ONE is all about minimalism: this range of door handles dispenses entirely with rosettes. The handle is positioned directly on the door and it is suitable for doors with standard locks. In the version with locking mechanism, the locking mechanism is located in the handle neck. A handle designed to meet highest expectations.

AVUS ONE



Griff
werk



AVUS ONE

Rosettenlos | Samtgrau, Graphitschwarz,
Kaschmirgrau, Gold
No rosette | velvet grey, graphite black,
cashmere grey, gold

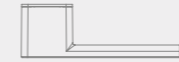

smart2lock by GRIFFWERK

AVUS ONE

Rosettenlos | Samtgrau, Graphitschwarz,
Kaschmirgrau, Gold
No rosette | velvet grey, graphite black,
cashmere grey, gold

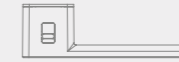

R8 ONE

Rosettenlos | Samtgrau, Graphitschwarz,
Kaschmirgrau
No rosette | matte stainless steel, graphite grey,
cashmere grey



smart2lock by GRIFFWERK

R8 ONE

Rosettenlos | Samtgrau, Graphitschwarz,
Kaschmirgrau
No rosette | matte stainless steel, graphite grey,
cashmere grey



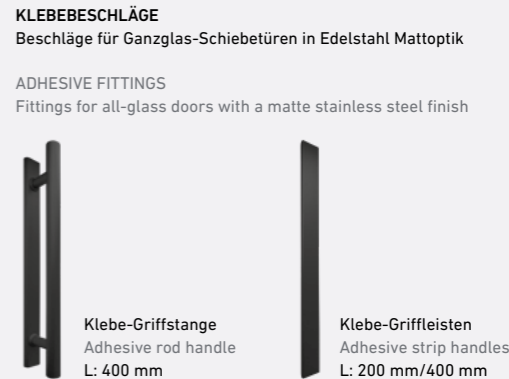
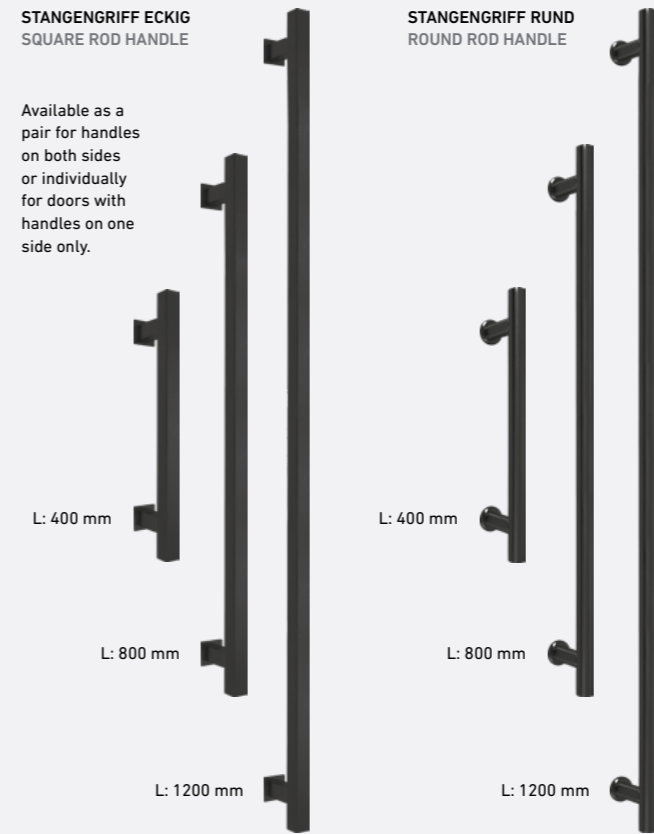
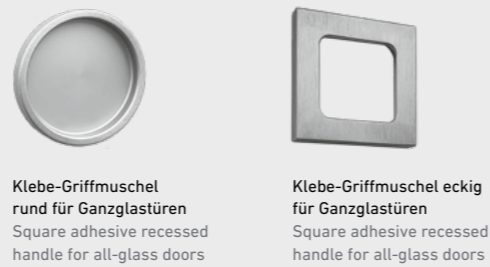
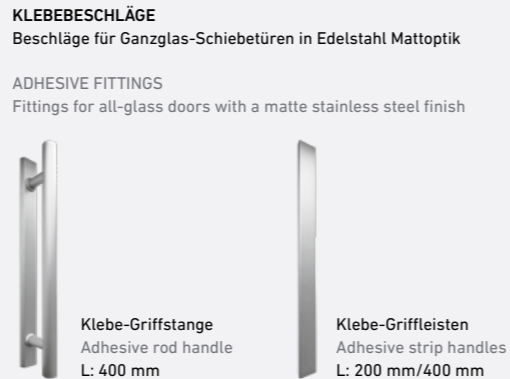

*ähnlich RAL9005 *like RAL9005

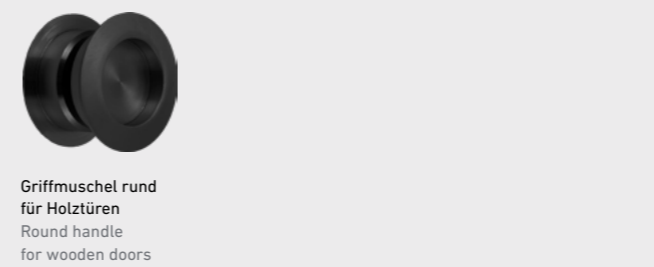

Kantenausführungen an G-TEC®-Türblättern

Edge designs for G-TEC® doors

Drei Kantenausführungen bieten individuelle Auswahlmöglichkeiten für jede Anforderung. Die kleine Rundkante schmeichelt mit gefälliger Rundung, die eckige Kante steht für gradlinige Klassik und die Premiumkante besticht mit ihrer Nullfugen-Technologie. There is a choice of three edge designs to meet any requirement. The small rounded edge has a flattering radius, the square edge represents clean classic design and the premium edge boasts zero-joint technology.

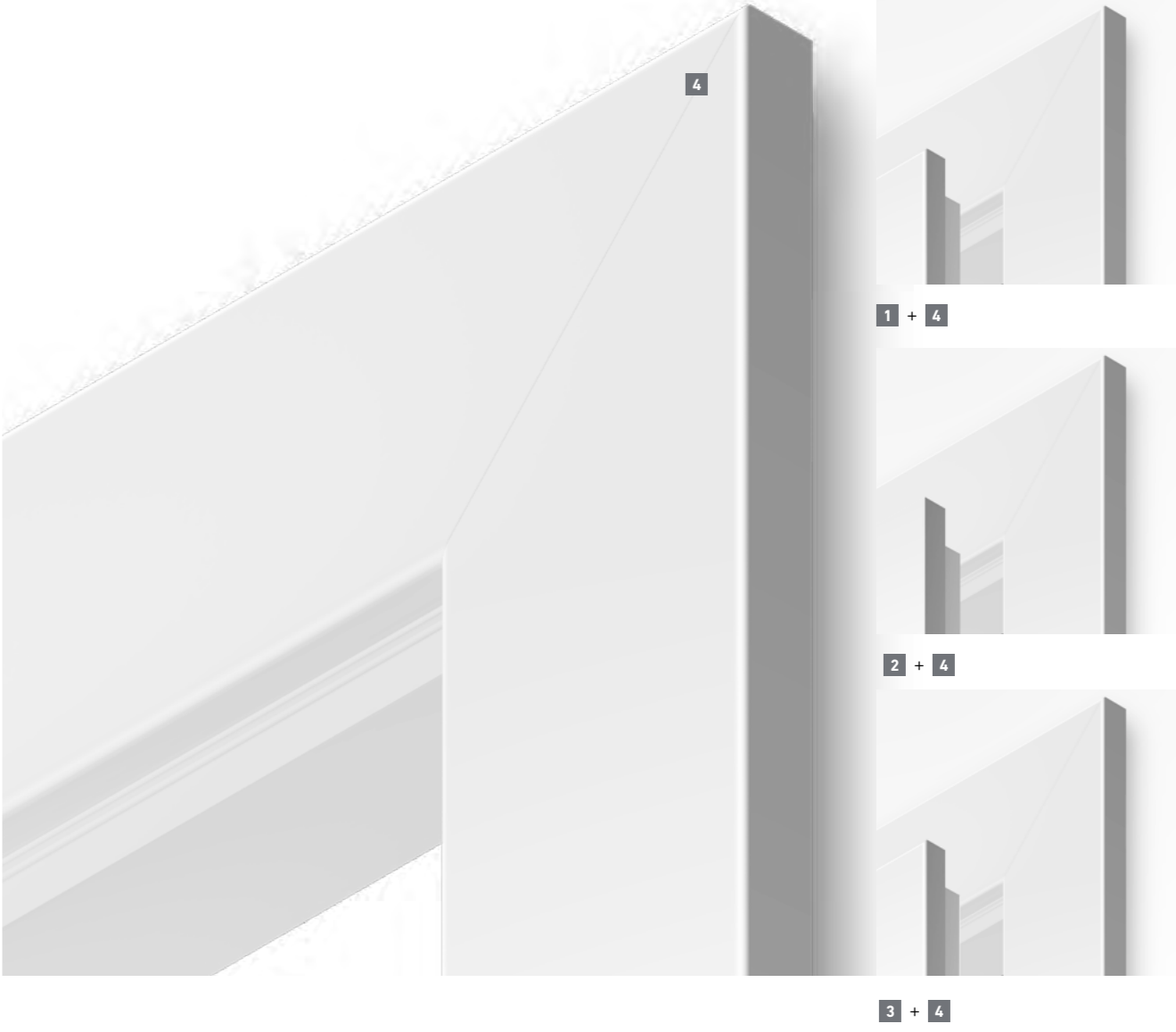
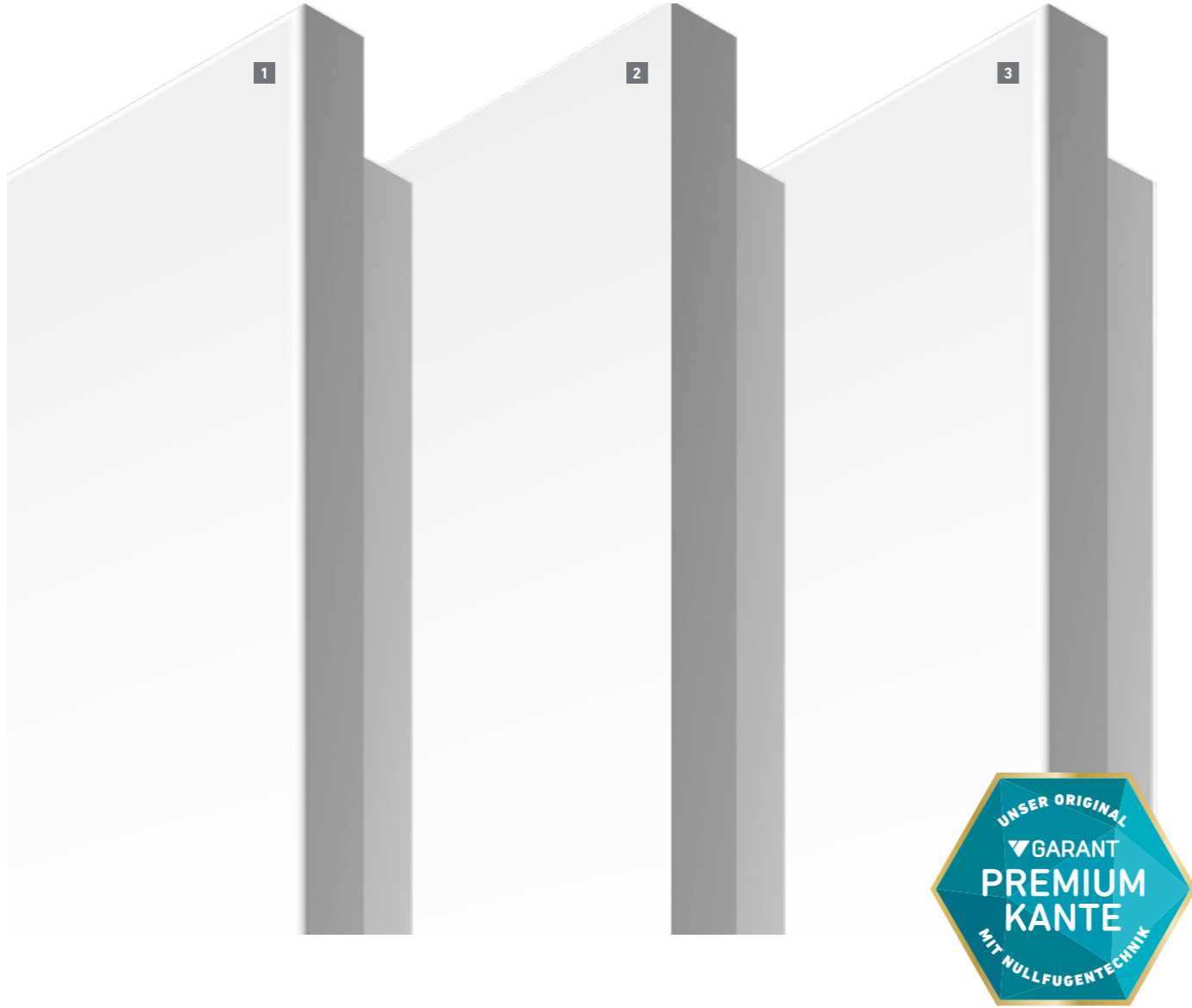

TÜRBLATT-QUERSCHNITT | DOOR CROSS-SECTION

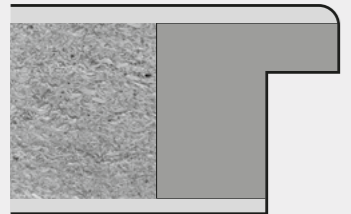

1 KLEINE RUNDKANTE (KR)
SMALL ROUNDED EDGE (KR)

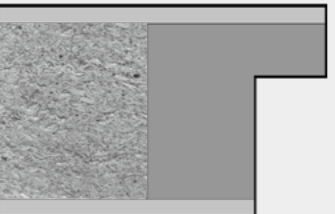

2 ECKIGE KANTE (EC)
SQUARE EDGE (EC)

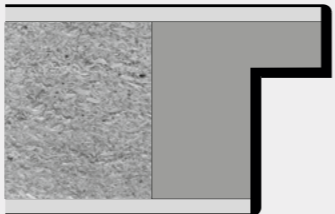

3 PREMIUMKANTE (PK2.0)
PREMIUM EDGE (PK2.0)

ZARGEN-QUERSCHNITT | FRAME CROSS-SECTION

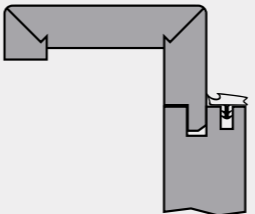

4 ZARGE MIT KLEINER RUNDKANTE
FRAME WITH SMALL ROUNDED EDGE

BÄNDER | HINGES

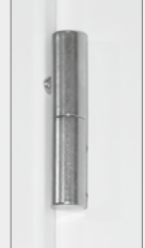

2-tlg. Band
2-piece hinge



3-tlg. Band
3-piece hinge

G-TEC®-Eigenschaften

G-TEC® properties

Hinterlässt keinen Abdruck, sondern Eindruck!
Excellent anti-fingerprint properties!

Die attraktive Modellreihe G-TEC® weist eine qualitativ hochwertige Oberfläche auf, die eine hochmatte Farbgebung gewährleistet. Diese Elemente garantieren eine angenehme Haptik mit praktischer Anti-Fingerprint-Eigenschaft. Gerade bei der Wahl einer dunklen Farbe ist es entscheidend, dass selbst bei einer intensiven Nutzung keine Fingerabdrücke zu sehen sind.

Zudem bleibt dieser Effekt auch nach einer sanften Reinigung erhalten. Lichtecht und weniger kratzempfindlich steht diese Oberfläche für eine lange Nutzungsdauer und eine gewisse Belastbarkeit. Türen und Zargen mit G-TEC®-Oberflächen werden mit einer kleinen Rundkante ausgestattet.

The attractive G-TEC® models have a high-quality finish that makes an ultra-matte varnish possible. These elements guarantee a pleasant feel and have practical anti-fingerprint properties. When you choose a dark colour it is important that no fingerprints are visible, even when the door is in frequent use.

The anti-fingerprint effect remains intact even after gentle cleaning. Light-fast and scratch-resistant, this finish is designed for a long lifespan and good durability. Doors and frames with G-TEC® finishes have a small round edge.



Anti-Fingerprint –
Keine Fingerabdrücke



Hochmatte
Trend-Oberfläche



Weniger kratzempfindlich
≥ 1,5 N nach Erichsen



Verbesserte
Oberflächenruhe



G-TEC® mit Funktion

G-TEC® for functional doors

Alle Türen mit G-TEC®-Oberflächen können auch als Funktionstür ausgestattet werden. Hier steht die volle Bandbreite von Türen mit Barrierefreiheit über einbruchssichere Türen, Türen mit Schall- und Wärmeschutz bis zur Brandschutztür zur Auswahl.

All the doors with G-TEC® finishes can be functional doors. There are a wide range of options in this respect, from accessibility doors to anti-burglary doors, doors with heat and noise insulation and fire doors.



BARRIEREFREIHEIT
ACCESSIBILITY



KLIMASTABILITÄT
CLIMATE STABILITY



MECHANISCHE BEANSPRUCHUNG
MECHANICAL STRESS



SCHALLSCHUTZ
NOISE INSULATION



EINBRUCHSCHUTZ
ANTI-BURGLARY



FEUERSCHUTZ
FIRE PROTECTION



RAUCHSCHUTZ
SMOKE PROTECTION



WÄRMEDÄMMSCHUTZ
HEAT INSULATION

G-TEC® mit Funktion G-TEC® functional doors

Unsere Funktionstüren schützen Sie und Ihre privaten oder geschäftlichen Räume und Güter vor den unterschiedlichsten negativen Einflüssen wie Schall, Einbruch, Feuer und Rauch.

Our functional doors protect you, your home and your business premises and assets from the diverse negative effects of noise, burglary, fire and smoke.



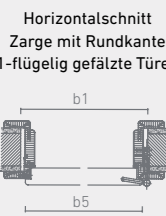
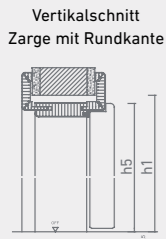
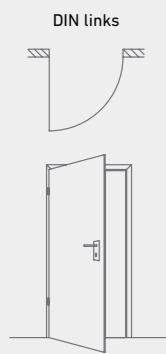
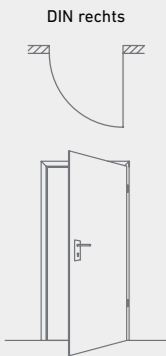

TÜRBLATTGRÖSSEN (VORZUGSGRÖSSEN NACH DIN 18101)											
EINFLÜGELIGE TÜREN						ZWEIFLÜGELIGE TÜREN					
Wandöffnungsmaß		Türblatt-Außenmaße				Wandöffnungsmaß		Türblatt-Außenmaße			
		Gefälztes Türblatt		Ungefälztes Türblatt				Gefälztes Türblatt		Ungefälztes Türblatt	
Breite (b1)	Höhe (h1)	Breite (b5)	Höhe (h5)	Breite (b5)	Höhe (h5)	Breite (b1)	Höhe (h1)	Breite (b5)	Höhe (h5)	Breite (b5)	Höhe (h5)
635	2005	610	1985	584	1972	1260	2005	1210	1985	1184	1972
760	2005	735	1985	709	1972	1510	2005	1460	1985	1434	1972
885	2005	860	1985	834	1972	1760	2005	1710	1985	1684	1972
1010	2005	985	1985	959	1972	2010	2005	1960	1985	1934	1972
1135	2005	1110	1985	1084	1972	2350	2005	2210	1985	2184	1972
1260	2005	1235	1985	1209	1972	2600	2005	2460	1985	2434	1972
635	2130	610	2110	584	2097	1260	2130	1210	2110	1184	2097
760	2130	735	2110	709	2097	1510	2130	1460	2110	1434	2097
885	2130	860	2110	834	2097	1760	2130	1710	2110	1684	2097
1010	2130	985	2110	959	2097	2010	2130	1960	2110	1934	2097
1135	2130	1110	2110	1084	2097	2350	2130	2210	2110	2184	2097
1260	2130	1235	2110	1209	2097	2600	2130	2460	2110	2434	2097

1. Normalhöhe nach DIN 18100 (Nennmaß) (h1)	2005				2130									
Maueröffnungshöhe min.-max. in [mm] (h1)	2000-2015*				2125-2140*									
Türblattaußenmaße in [mm] (h5)	1985				2110									
2. Normalbreite (1 flg.) nach DIN 18100 (Nennmaß) (b1)	635		885		1010		1260							
Maueröffnungsbreite min.-max. in [mm] (b1)	625-645*		875-895*		1000-1020*		1250-1270*							
Türblattaußenmaße in [mm] (b5)	610		860		985		1235							
3. Normalbreite (2 flg.) nach DIN 18100 (Nennmaß)	1260		1510		1760		2010							
Maueröffnungsbreite min.-max. in [mm]	1250-1270*		1500-1520*		1750-1770*		2000-2020*							
Türblattaußenmaße in [mm]	1210		1460		1710		1960							
* Bei Einsatz einer Holzumfassungszarge empfiehlt GARANT das Maximalmaß.														
4. Verstellbarkeit in [mm]	80-100	100-120	120-140	140-160	160-180	180-200	200-220	215-235	235-255	255-275	265-285	285-305	305-320	320-340
Futterbreite/Wanddicke	85	105	125	145	165	185	205	220	240	260	270	290	310	325

ZUBEHÖR

SCHLÖSSER

DICHTUNG



MODELL: BUNTART-SCHLOSS



MODELL: PROFILZYLINDER-SCHLOSS



MODELL: SCHLOSS FÜR BADTÜREN



MODELL: ABSENKBARE BODENDICHTUNG

BÄNDER



MODELL: BANDKOMBINATION V 3420 WF FÜR HOLZZARGE



MODELL: BANDKOMBINATION V 4426 WF FÜR HOLZZARGE



MODELL: BANDKOMBINATION V 8026 WF FÜR STAHLZARGE

DOOR LEAF SIZES (STANDARD SIZES AS PER DIN 18101)											
SINGLE-LEAF DOORS						DOUBLE-LEAF DOORS					
Wall aperture measurements		Door leaf external measurements				Wall aperture measurements		Door leaf external measurements			
		Rebated door leaf		Flush door leaf				Rebated door leaf		Flush door leaf	
Length (b1)	Height (h1)	Length (b5)	Height (h5)	Length (b5)	Height (h5)	Length (b1)	Height (h1)	Length (b5)	Height (h5)	Length (b5)	Height (h5)
635	2005	610	1985	584	1972	1260	2005	1210	1985	1184	1972
760	2005	735	1985	709	1972	1510	2005	1460	1985	1434	1972
885	2005	860	1985	834	1972	1760	2005	1710	1985	1684	1972
1010	2005	985	1985	959	1972	2010	2005	1960	1985	1934	1972
1135	2005	1110	1985	1084	1972	2350	2005	2210	1985	2184	1972
1260	2005	1235	1985	1209	1972	2600	2005	2460	1985	2434	1972
635	2130	610	2110	584	2097	1260	2130	1210	2110	1184	2097
760	2130	735	2110	709	2097	1510	2130	1460	2110	1434	2097
885	2130	860	2110	834	2097	1760	2130	1710	2110	1684	2097
1010	2130	985	2110	959	2097	2010	2130	1960	2110	1934	2097
1135	2130	1110	2110	1084	2097	2350	2130	2210	2110	2184	2097
1260	2130	1235	2110	1209	2097	2600	2130	2460	2110	2434	2097

1. Standard height as per DIN 18100 (nominal height) (h1)	2005				2130									
Wall aperture height min.-max. in [mm] (h1)	2000-2015*				2125-2140*									
Door leaf external measurements [mm] (h5)	1985				2110									
2. Standard height (single leaf) as per DIN 18100 (nominal height) (b1)	635		885		1010		1260							
Wall aperture width min.-max. in [mm] (b1)	625-645*		875-895*		1000-1020*		1250-1270*							
Door leaf external measurements [mm] (b5)	610		860		985		1235							
3. Standard height (double leaf) as per DIN 18100 (nominal height) (b1)	1260		1510		1760		2010							
Wall aperture width min.-max. in [mm]	1250-1270*		1500-1520*		1750-1770*		2000-2020*							
Door leaf external measurements [mm]	1210		1460		1710		1960							
* GARANT recommends the maximum size if a closed wooden frame is being used.														
4. Adjustability in [mm]	80-100	100-120	120-140	140-160	160-180	180-200	200-220	215-235	235-255	255-275	265-285	285-305	305-320	320-340
Jamb width/ wall thickness	85	105	125	145	165	185	205	220	240	260	270	290	310	325

ACCESSORIES

LOCKS

SEALS



MODEL: WARDER KEY LOCK



MODEL: PROFILE CYLINDER LOCK



MODEL: BATHROOM DOOR LOCK



MODEL: LOWERABLE BOTTOM SEAL

HINGES



MODEL: HINGE COMBINATION V 3420 WF FOR WOODEN FRAMES



MODEL: HINGE COMBINATION V 4426 WF FOR WOODEN FRAMES



MODEL: HINGE COMBINATION V 8026 WF FOR STEEL FRAMES

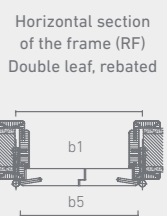
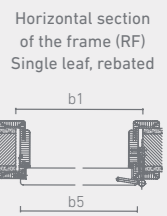
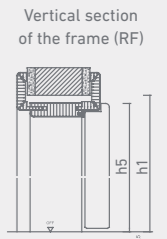
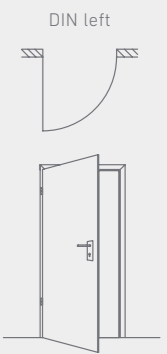
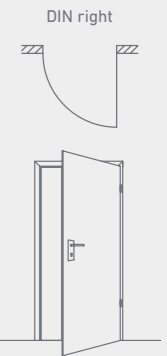

NORMTÜREN
STANDARD DOORS

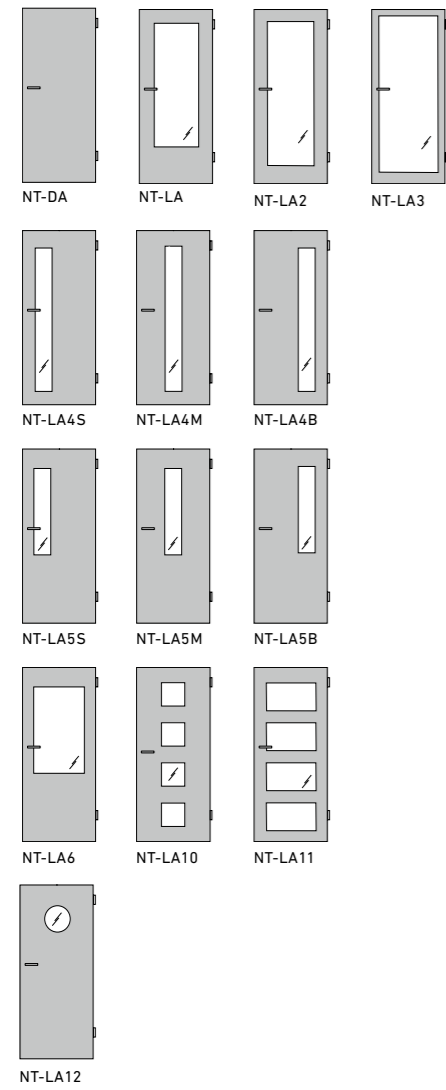

AURA
AURA

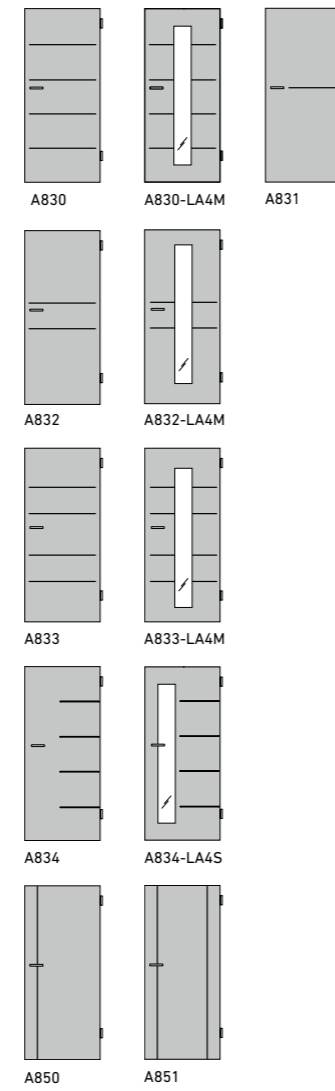

OBERFLÄCHEN | FINISHES

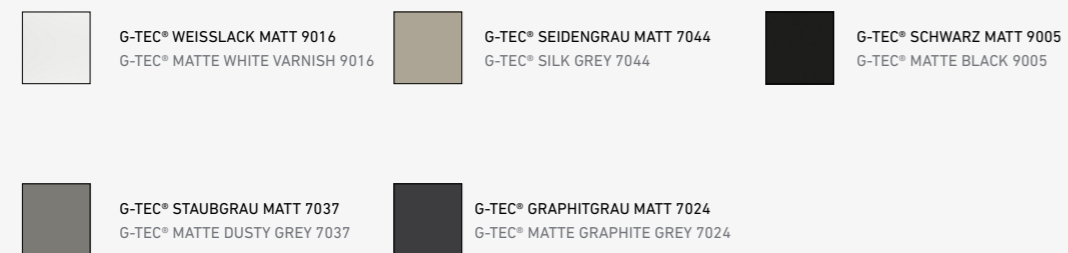

GANZGLASTÜREN DESIGN
ALL-GLASS DESIGN DOORS

LASER-VEREDELUNG | LASER DÉCOR

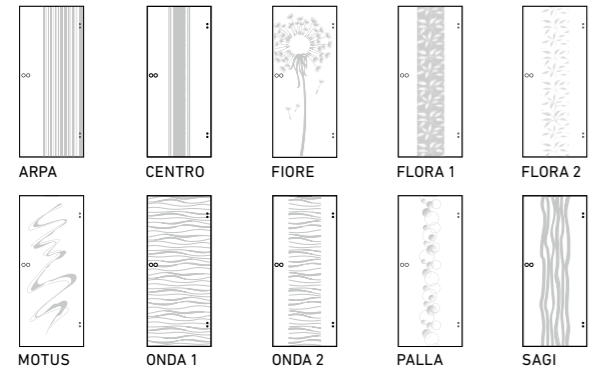

SIEBDRUCK-VEREDELUNG | SCREEN PRINTED DÉCOR

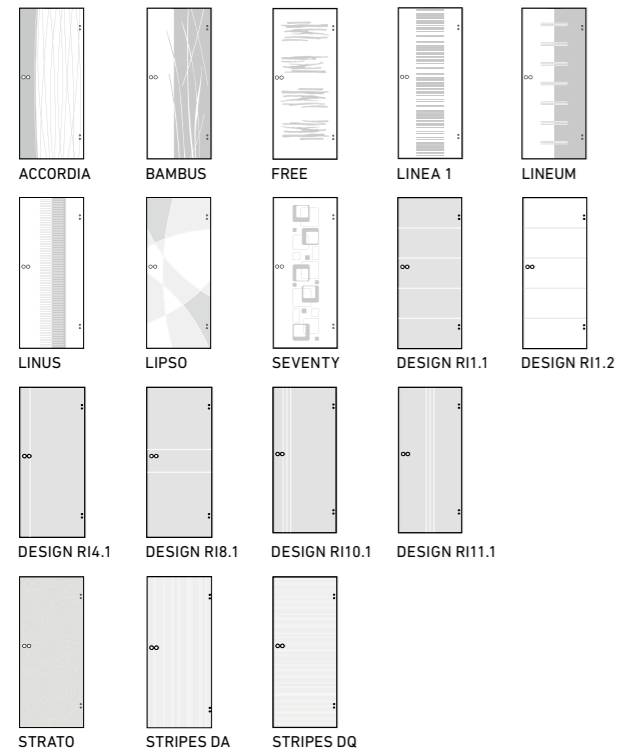

GANZGLASTÜREN ORNAMENT (NORM)
PATTERNED ALL-GLASS DOORS (STANDARD)

STANDARD-ORNAMENTGLAS | STANDARD PATTERNED GLASS

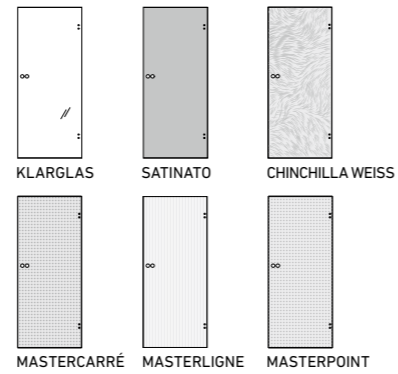

DESIGN-ORNAMENTGLAS | DESIGN PATTERNED GLASS

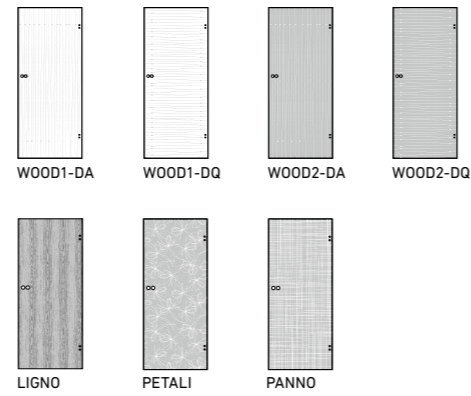

LICHTAUSSCHNITTGLÄSER
GLASS PANELS

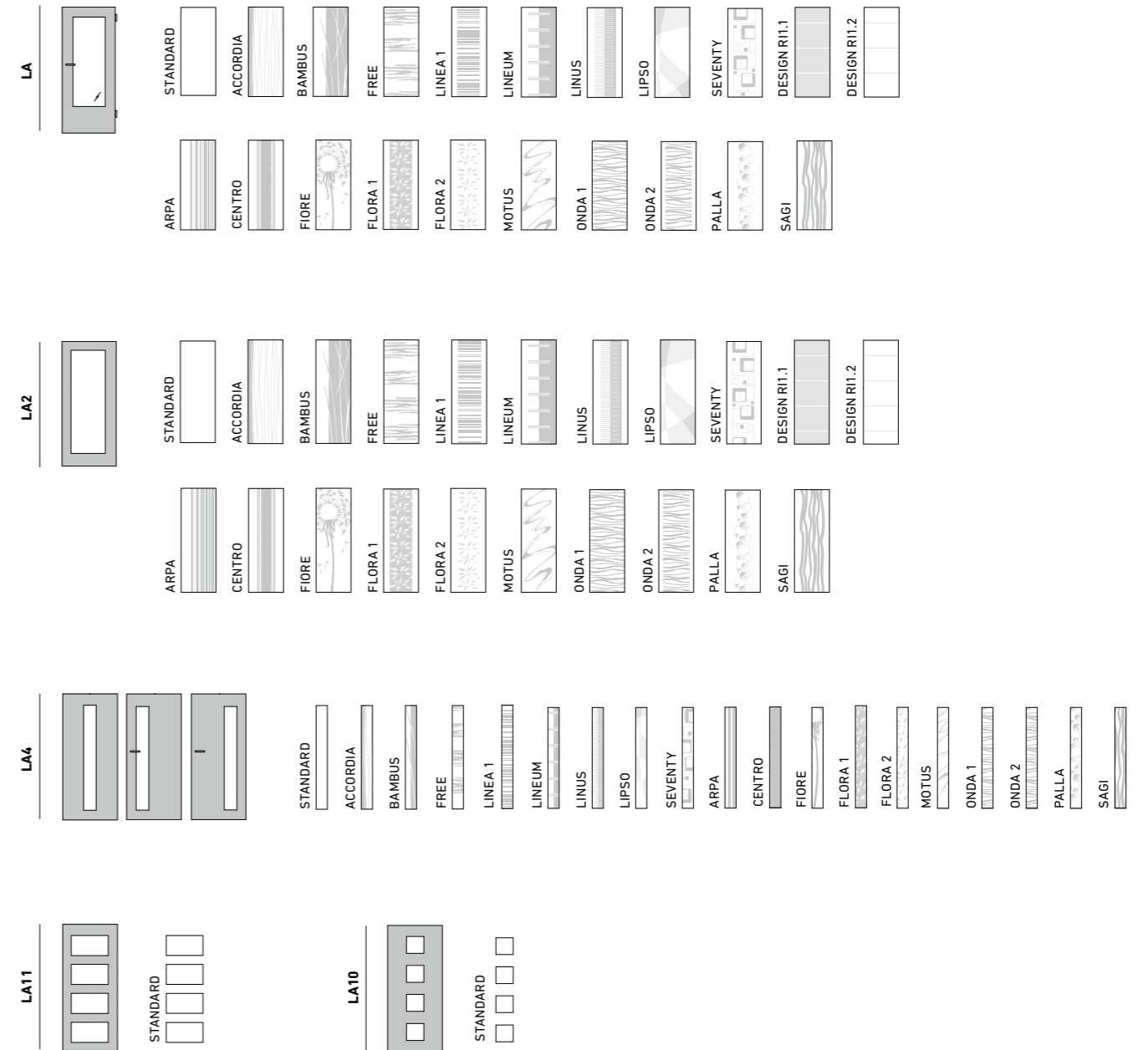

GLASBEISPIELE
EXAMPLES OF GLASS

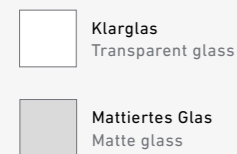

STANDARD-LICHTAUSSCHNITTGLÄSER ALS ORNAMENTGLAS
STANDARD PATTERNED GLASS PANELS

- STANDARD-ORNAMENTGLÄSER**
- KLARGLAS
 - SATINATO
 - MASTERCARRÉ
 - MASTERLIGNE
 - MASTERPOINT
 - CHINCHILLA WEISS

- DESIGN-ORNAMENTGLÄSER**
- LIGNO
 - PETALI
 - PANNO
 - WOOD1-DA
 - WOOD1-DQ
 - WOOD2-DA
 - WOOD2-DQ

SPROSSENRAHMEN
MUNTIN FRAMES

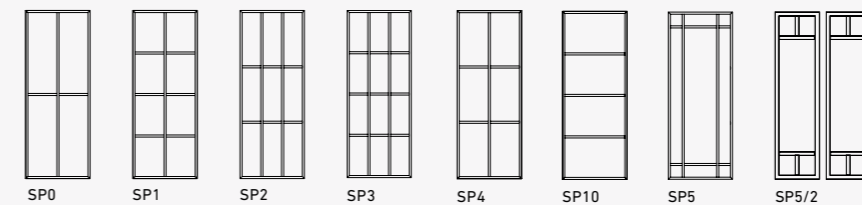

GARANT Türen und Zargen GmbH

OT Icktershausen
Garantstraße 1, Gewerbepark Thörey
99334 Amt Wachsenburg

T +49 (0) 36202/91-0
F +49 (0) 36202/91-150
E service@garant.de
I www.garant.de

Ein Unternehmen der Arbonia Doors

ARBONIA 
Doors

Ihr GARANT-Fachhändler:



PRÜTTING

Bau- und Möbelschreinerei

Hauptstraße 69 • 91355 Hiltpoltstein

 09192 7887
 info@pruetting.de
 www.pruetting.de



 **GARANT**
Türen für mein Zuhause

Stand 05/2023

Drucktechnisch bedingte Farbabweichungen
sowie Änderungen am Produkt vorbehalten.

Gestaltung: Zentral-Marketing GARANT

Nur die mit FSC® gekennzeichneten Produkte sind zertifiziert.*

