



[garant.de](http://garant.de)

Weil ich weiß, was mir gefällt  
Because I know what I like

Zeitlose Weißlacktüren für moderne Raumgestaltung  
Timeless white varnish doors for modern interior design concepts



# Themen

## Themes

Seite 04–05 DieTÜR – Digitales Türentool | DieTÜR – Outil numérique pour les portes

### Seite 06–15 **NORMTÜREN-PROGRAMM | STANDARD DOOR RANGE**

Seite 08–13 NORMTÜREN | STANDARD doors

Seite 14–15 Gesamtübersicht NORMTÜREN | Overview of all STANDARD DOORS

### Seite 16–25 **DESIGNTÜREN-PROGRAMM | DESIGN DOOR RANGE**

Seite 18–23 AURA | AURA

Seite 24–25 Gesamtübersicht DESIGNTÜREN | Overview of all DESIGN DOORS

### Seite 26–53 **PROFILTÜREN-PROGRAMM | PROFILE DOOR RANGE**

Seite 28–33 MILANO | MILANO

Seite 34–39 RIVA | RIVA

Seite 40–45 COMO | COMO

Seite 46–51 PARMA | PARMA

Seite 52–53 Gesamtübersicht PROFILTÜREN | Overview of all PROFILE DOORS

### Seite 54–63 **STILTÜREN-PROGRAMM | STYLISTIC DOOR RANGE**

Seite 56–61 AMRUM | AMRUM

Seite 62–63 Gesamtübersicht STILTÜREN | Overview of all STYLISTIC DOORS

Seite 64–75 Elemente | Elements

### Seite 76–95 **TECHNISCHE DETAILS | TECHNICAL DETAILS**

Seite 78–85 Glas-Übersicht | Glass overview

Seite 86–101 Beschläge | Fittings

Seite 102–105 Zargenausführungen, Bänder | Frame types, hinges

Seite 106–107 Weißlack-Eigenschaften | White varnishproperties

Seite 108–109 Weißlack mit Funktion | Functional white varnish

Seite 110–111 Maße | Dimensions

Seite 112–115 Gesamtübersicht | General overview

# Uneingeschränkt umweltverträglich

## Totally eco-friendly

Makellose Lackierungen sind einfach faszinierend. Mit hochwertigen, umweltschonenden UV-gehärteten Acryllacken, modernen Walz- und Spritzverfahren und permanenter Qualitätskontrolle sorgen wir dafür, dass unsere Türen auch auf Jahre hinaus nichts von ihrer Faszination verlieren. So sind unsere seidenmatten Weißlacktüren überall dort zu Hause, wo klassisches Türdesign und zeitgemäßer Pflegekomfort gefragt sind.

Gut zu wissen: Jede GARANT-Tür wird in unserem Werk in Thüringen hergestellt, wo moderne, computergesteuerte Maschinen für höchste Präzision und Qualität sorgen. Erst die handwerkliche Arbeit und das geschulte Auge erfahrener Mitarbeiter geben ihr jedoch den letzten Schliff.

Perfect varnish finishes are simply fascinating. We use high-quality, eco-friendly UV-hardened acrylic varnish, modern roller coating and spray methods and continuous quality controls to ensure that our doors retain their fascinating qualities over the years. Our silk matte and white varnish doors are perfect for all home design scenarios requiring classic or contemporary low-maintenance doors.

Good to know: Every GARANT door is manufactured at our factory in Thuringia using computer-aided machines for maximum precision and quality. However, we depend on the skilled eyes of our experienced craftsmen to add the finishing touches.



# DieTÜR – Digitales Türentool

## Über 1 Millionen Kombinationen für Ihre Wunschtür

### BEQUEM WUNSCHTÜR KONFIGURIEREN

In einer Türenaustellung ist nur für eine bestimmte Anzahl an Modellen Platz. Nicht alle Varianten einer Tür können gezeigt werden. Um diese Lücke zu schließen, haben wir das Online-Tool „DieTÜR“ entwickelt. Hierüber haben Sie und Ihre Kunden Zugriff auf über 1 Millionen Kombinationen einer Tür – und mit jedem Update werden es mehr. Ein Highlight bietet die Funktion „Tür im Raum darstellen“. So kann sich der Kunde seine Wunschtür besser in seinem Haus vorstellen.

Außerdem kann er seine Wunschliste samt QR-Code ausdrucken und damit zu Ihnen in den Fachhandel gehen. Vor Ort scannen Sie einfach den QR-Code und wissen sofort, was der Kunde möchte.

QR-CODE AUF DEN FOLGSEITEN SCANNEN UND EINFACH SELBST KOMBINIEREN

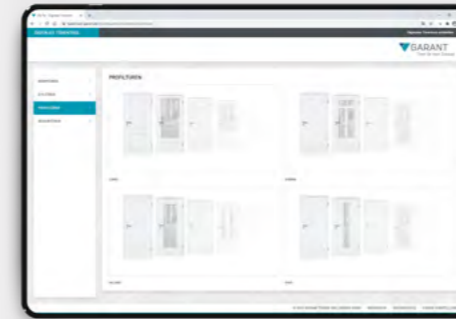
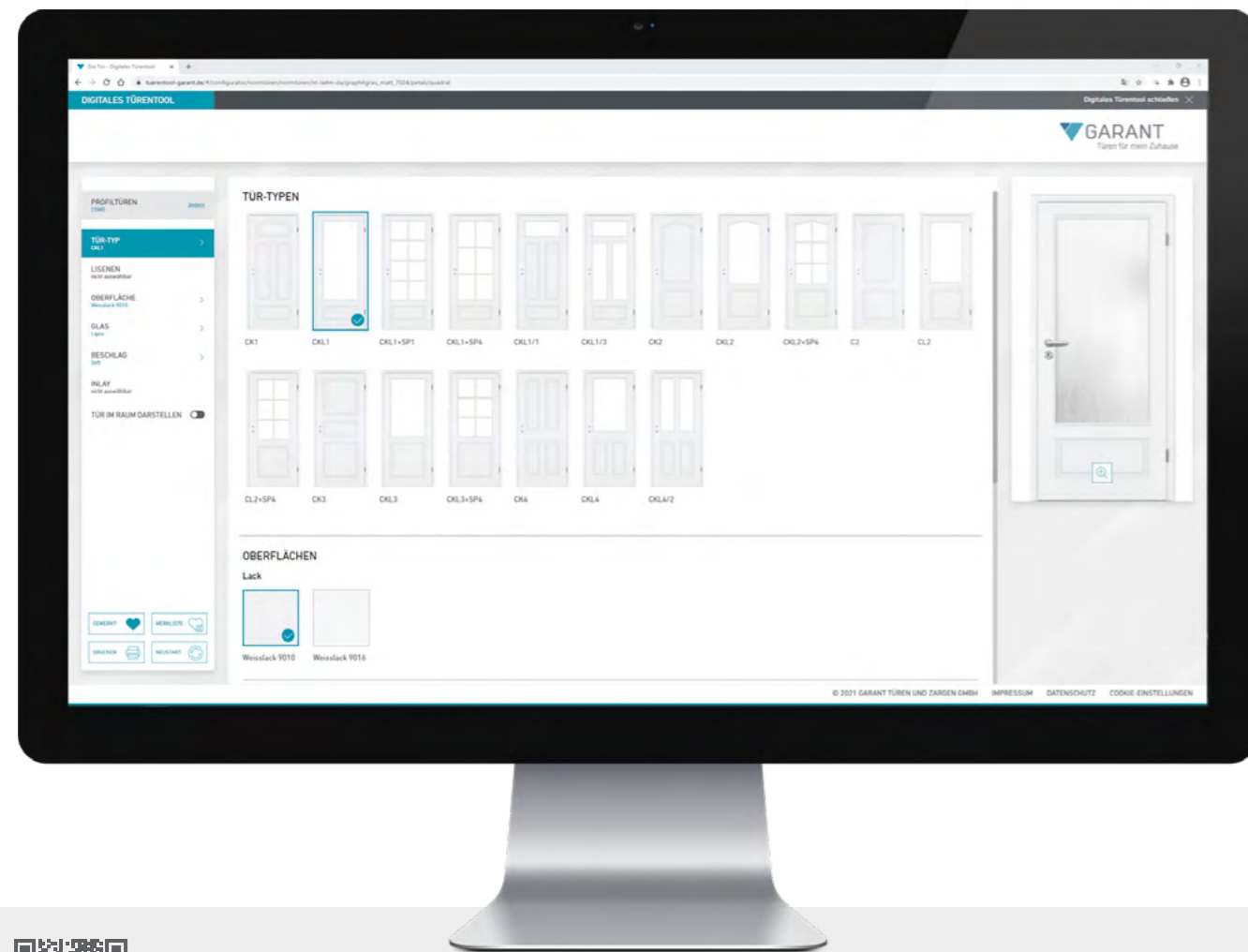

### SCHRITT 1:

#### SO EINFACH FUNKTIONIERT DAS ONLINE-TÜRENTOOL VON GARANT

Im ersten Schritt können Sie oder auch der Kunde daheim zwischen den 4 verschiedenen Türkategorien Norm-, Stil-, Profil- und Designtüren auswählen. Einfach anklicken und Sie landen in der jeweiligen Übersicht. Dort konfigurieren Sie die Wunschtür für Ihren Kunden bis ins kleinste Detail. Ihr Kunde kann auch schon vorarbeiten und trifft eine erste Auswahl vorab zu Hause und Sie beraten detailliert weiter.

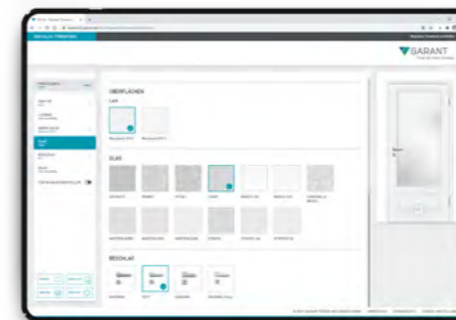

### SCHRITT 2:

#### INDIVIDUALISIERUNG DER TÜR, JETZT AUCH MIT GRIFFWERK-BESCHLÄGEN

Innerhalb der jeweiligen Kategorie können Sie zwischen verschiedenen Türtypen wählen – zum Beispiel mit oder ohne Glas. Oder soll es vielleicht eine Oberfläche in Eiche oder Ahorn sein? Sie haben die Wahl zwischen verschiedensten Oberflächen, Gläsern und Beschlägen. Je nach Türtyp bieten sich unterschiedlich viele Auswahlmöglichkeiten.

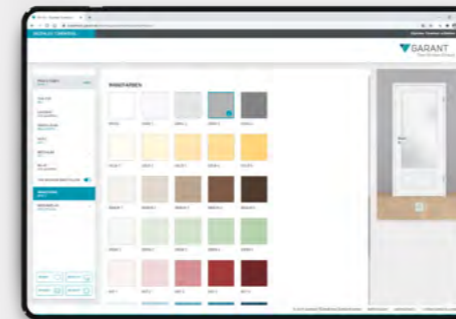

### TÜR IM RAUM

Mit einem Klick sieht der Kunde mit der Funktion „Tür im Raum“ seine konfigurierte Wunschtür im Umfeld von Wand und Boden und kann so überprüfen, ob seine Vorstellungen auch stimmig zur Raumsituation – TÜR, BODEN, WAND – passen. Um die beste Kombination zu finden, können Wandfarbe und Bodenbelag farblich passend zur Tür getestet werden.



### DAS ERGEBNIS:

#### BERATUNG UND BESTELLUNG BEIM FACHHÄNDLER

Wenn der Kunde seine Wunschtür zu Hause konfiguriert hat, kann er sie einfach auf den Merkzettel packen oder gleich ausdrucken und damit für eine tiefere Beratung und anschließende Bestellung zu Ihnen gehen.



KLICK

Englische Übersetzung dieser Seite | English translation of this page

# Das NORMTÜREN-Programm

The STANDARD DOOR range

Das gute und sichere Gefühl, die richtige Wahl getroffen zu haben:  
Unsere NORMTÜREN sorgen jeden Tag für entspannte Wohnlichkeit.

You can be assured of making the right choice because the doors in our  
STANDARD range provide relaxed comfort and convenience day after day.





**NORMTÜREN**  
**Weißlack 9016**

STANDARD DOORS  
White Varnish 9016

Türen, für die man sich immer wieder entscheiden würde: Einfach schön – und mit einer großen Auswahl an interessanten Oberflächen und Details.

Doors that people want to buy again and again: simply beautiful – with a comprehensive choice of interesting finishes and details.



NORMTÜR  
Weißlack 9016

Durchblick inklusive  
With a vision

Unsere Weißlacktüren sorgen in Kombination mit Glas für moderne Raum-Transparenz.  
Our white varnish doors provide modern transparency in combination with glass panels.

QUERSCHNITT | CROSS

KLEINE RUNDKANTE | SMALL ROUNDED EDGE

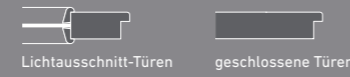

ECKIGE KANTE | SQUARE EDGE

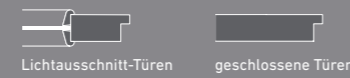

BESCHLAG  
NOVO

GRAPHITSCHWARZ  
GRAPHITE BLACK



BB/PZ/WC



smart2lock

EDELSTAHL MATT  
STAINLESS STEEL MATT



BB/PZ/WC



smart2lock



<b>MODELL</b>	1	NORMTÜR NT-DA
<b>OBERFLÄCHE</b>		Weißlack 9016
<b>GLAS</b>		-
<b>ZARGE</b>		KR1
<b>BESCHLAG</b>		NOVO, Graphitschwarz
<b>MODEL</b>		STANDARD DOOR NT-DA
<b>FINISH</b>		White varnish 9016
<b>GLASS</b>		-
<b>FRAME</b>		KR1
<b>FITTINGS</b>		NOVO, Graphite black

<b>MODELL</b>	2	NORMTÜR NT-LA11-DA
<b>OBERFLÄCHE</b>		Weißlack 9016
<b>GLAS</b>		SATINATO, Standard-Ornamentglas
<b>ZARGE</b>		KR1
<b>BESCHLAG</b>		NOVO, Graphitschwarz
<b>MODEL</b>		STANDARD DOOR NT-LA11-DA
<b>FINISH</b>		White varnish 9016
<b>GLASS</b>		SATINATO, standard patterned glass
<b>FRAME</b>		KR1
<b>FITTINGS</b>		NOVO, Graphite black

<b>MODELL</b>	3	NORMTÜR NT-LA-DA
<b>OBERFLÄCHE</b>		Weißlack 9016
<b>GLAS</b>		SATINATO, Standard-Ornamentglas
<b>ZARGE</b>		KR1
<b>BESCHLAG</b>		NOVO, Graphitschwarz
<b>MODEL</b>		STANDARD DOOR NT-LA-DA
<b>FINISH</b>		White varnish 9016
<b>GLASS</b>		SATINATO, standard patterned glass
<b>FRAME</b>		KR1
<b>FITTINGS</b>		NOVO, Graphite black

<b>MODELL</b>	4	NORMTÜR NT-LA-DA+SP4
<b>OBERFLÄCHE</b>		Weißlack 9016
<b>GLAS</b>		SATINATO, Standard-Ornamentglas
<b>ZARGE</b>		KR1
<b>BESCHLAG</b>		NOVO, Graphitschwarz
<b>MODEL</b>		STANDARD DOOR NT-LA-DA+SP4
<b>FINISH</b>		White varnish 9016
<b>GLASS</b>		SATINATO, standard patterned glass
<b>FRAME</b>		KR1
<b>FITTINGS</b>		NOVO, Graphite black

<b>MODELL</b>	5	NORMTÜR NT-LA4S-DA
<b>OBERFLÄCHE</b>		Weißlack 9016
<b>GLAS</b>		SATINATO, Standard-Ornamentglas
<b>ZARGE</b>		KR1
<b>BESCHLAG</b>		NOVO, Edelstahl Matt
<b>MODEL</b>		STANDARD DOOR NT-LA4S-DA
<b>FINISH</b>		White varnish 9016
<b>GLASS</b>		SATINATO, standard patterned glass
<b>FRAME</b>		KR1
<b>FITTINGS</b>		NOVO, Stainless steel matt

<b>MODELL</b>	6	NORMTÜR NT-LA4M-DA
<b>OBERFLÄCHE</b>		Weißlack 9016
<b>GLAS</b>		SATINATO, Standard-Ornamentglas
<b>ZARGE</b>		KR1
<b>BESCHLAG</b>		NOVO, Edelstahl Matt
<b>MODEL</b>		STANDARD DOOR NT-LA4M-DA
<b>FINISH</b>		White varnish 9016
<b>GLASS</b>		SATINATO, standard patterned glass
<b>FRAME</b>		KR1
<b>FITTINGS</b>		NOVO, Stainless steel matt

<b>MODELL</b>	7	NORMTÜR NT-LA2-DA
<b>OBERFLÄCHE</b>		Weißlack 9016
<b>GLAS</b>		STRIPES DQ, Siebdruck-Veredelung
<b>ZARGE</b>		KR1
<b>BESCHLAG</b>		NOVO, Edelstahl Matt
<b>MODEL</b>		STANDARD DOOR NT-LA2-DA
<b>FINISH</b>		White varnish 9016
<b>GLASS</b>		STRIPES DQ, screen printed décor
<b>FRAME</b>		KR1
<b>FITTINGS</b>		NOVO, Stainless steel matt



**JETZT TESTEN**  
Im Online-Türentool „DieTÜR“ von GARANT kombinieren Sie mit einfachen Klicks Ihre individuelle Wunschtür.  
**TEST NOW**  
Use GARANT's online door tool 'DieTÜR' to create your own custom door in just a few clicks.



NORMTÜR  
Weißlack 9010

Hier ist Entspannung  
die Norm

Relaxation is the  
norm here

So wird wohnliche Leichtigkeit ganz selbstverständlich.  
Home comfort soon becomes.

QUERSCHNITT | CROSS

RUNDKANTE | ROUNDED EDGE



ECKIGE KANTE | SQUARE EDGE



BESCHLAG  
MONO

GRAPHITSCHWARZ  
GRAPHITE BLACK



BB/PZ/WC



smart2lock

EDELSTAHL MATT  
STAINLESS STEEL MATT



BB/PZ/WC



smart2lock



<b>MODELL</b>	1	NORMTÜR NT-DA
<b>OBERFLÄCHE</b>		Weißlack 9010
<b>GLAS</b>		-
<b>ZARGE</b>		R1
<b>BESCHLAG</b>		MONO, Graphitschwarz
<b>MODEL</b>		STANDARD DOOR NT-DA
<b>FINISH</b>		White varnish 9010
<b>GLASS</b>		-
<b>FRAME</b>		R1
<b>FITTINGS</b>		MONO, Graphite black

<b>MODELL</b>	2	NORMTÜR NT-LA11-DA
<b>OBERFLÄCHE</b>		Weißlack 9010
<b>GLAS</b>		SATINATO, Standard-Ornamentglas
<b>ZARGE</b>		R1
<b>BESCHLAG</b>		MONO, Graphitschwarz
<b>MODEL</b>		STANDARD DOOR NT-LA11-DA
<b>FINISH</b>		White varnish 9010
<b>GLASS</b>		SATINATO, standard patterned glass
<b>FRAME</b>		R1
<b>FITTINGS</b>		MONO, Graphite black

<b>MODELL</b>	3	NORMTÜR NT-LA-DA
<b>OBERFLÄCHE</b>		Weißlack 9010
<b>GLAS</b>		SATINATO, Standard-Ornamentglas
<b>ZARGE</b>		R1
<b>BESCHLAG</b>		MONO, Graphitschwarz
<b>MODEL</b>		STANDARD DOOR NT-LA-DA
<b>FINISH</b>		White varnish 9010
<b>GLASS</b>		SATINATO, standard patterned glass
<b>FRAME</b>		R1
<b>FITTINGS</b>		MONO, Graphite black

<b>MODELL</b>	4	NORMTÜR NT-LA-DA+SP4
<b>OBERFLÄCHE</b>		Weißlack 9010
<b>GLAS</b>		SATINATO, Standard-Ornamentglas
<b>ZARGE</b>		R1
<b>BESCHLAG</b>		MONO, Graphitschwarz
<b>MODEL</b>		STANDARD DOOR NT-LA-DA+SP4
<b>FINISH</b>		White varnish 9010
<b>GLASS</b>		SATINATO, standard patterned glass
<b>FRAME</b>		R1
<b>FITTINGS</b>		MONO, Graphite black

<b>MODELL</b>	5	NORMTÜR NT-LA4S-DA
<b>OBERFLÄCHE</b>		Weißlack 9010
<b>GLAS</b>		SATINATO, Standard-Ornamentglas
<b>ZARGE</b>		R1
<b>BESCHLAG</b>		MONO, Edelstahl Matt
<b>MODEL</b>		STANDARD DOOR NT-LA4S-DA
<b>FINISH</b>		White varnish 9010
<b>GLASS</b>		SATINATO, standard patterned glass
<b>FRAME</b>		R1
<b>FITTINGS</b>		MONO, Stainless steel matt

<b>MODELL</b>	6	NORMTÜR NT-LA4M-DA
<b>OBERFLÄCHE</b>		Weißlack 9010
<b>GLAS</b>		SATINATO, Standard-Ornamentglas
<b>ZARGE</b>		R1
<b>BESCHLAG</b>		MONO, Edelstahl Matt
<b>MODEL</b>		STANDARD DOOR NT-LA4M-DA
<b>FINISH</b>		White varnish 9010
<b>GLASS</b>		SATINATO, standard patterned glass
<b>FRAME</b>		R1
<b>FITTINGS</b>		MONO, Stainless steel matt

<b>MODELL</b>	7	NORMTÜR NT-LA2-DA
<b>OBERFLÄCHE</b>		Weißlack 9010
<b>GLAS</b>		PETALI, Design-Ornamentglas
<b>ZARGE</b>		R1
<b>BESCHLAG</b>		MONO, Edelstahl Matt
<b>MODEL</b>		STANDARD DOOR NT-LA2-DA
<b>FINISH</b>		White varnish 9010
<b>GLASS</b>		PETALI, design patterned glass
<b>FRAME</b>		R1
<b>FITTINGS</b>		MONO, Stainless steel matt



**JETZT TESTEN**  
Im Online-Türentool „DieTÜR“ von GARANT kombinieren Sie mit einfachen Klicks Ihre individuelle Wunschtür.  
**TEST NOW**  
Use GARANT's online door tool 'DieTÜR' to create your own custom door in just a few clicks.

# Gesamtübersicht NORMTÜREN-Programm

## Overview of the STANDARD DOOR range

NORMTÜREN | STANDARD DOORS

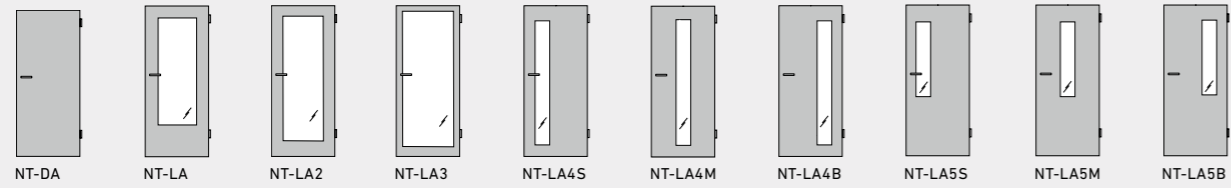

NT-DA NT-LA NT-LA2 NT-LA3 NT-LA4S NT-LA4M NT-LA4B NT-LA5S NT-LA5M NT-LA5B

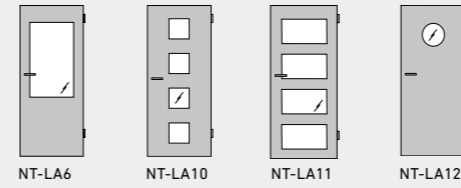

NT-LA6 NT-LA10 NT-LA11 NT-LA12

**OBERFLÄCHEN FINISHES**

WEISSLACK 9016  
WHITE VARNISH 9016

**TÜRKANTEN EDGES**

**OBERFLÄCHEN FINISHES**

WEISSLACK 9010  
WHITE VARNISH 9010

**TÜRKANTEN EDGES**

GLÄSER | GLASS PANELS

### MODERNE ORNAMENTGLÄSER | MODERN PATTERNED GLASS PANELS

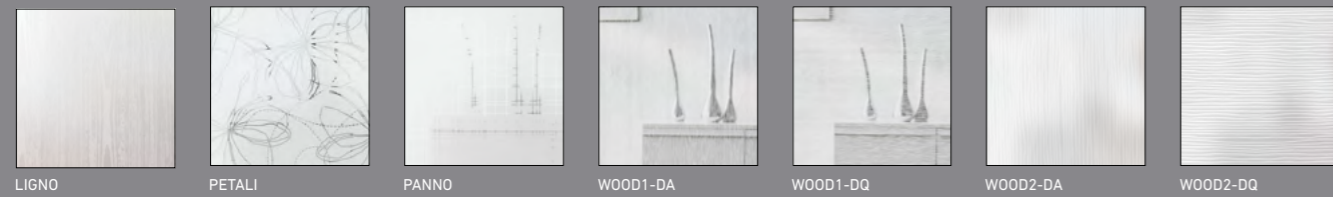

LIGNO PETALI PANNO WOOD1-DA WOOD1-DQ WOOD2-DA WOOD2-DQ

### DESIGNGLÄSER – SIEBDRUCK-VEREDELUNG | DESIGN GLASS PANELS – SCREEN PRINTED DÉCOR

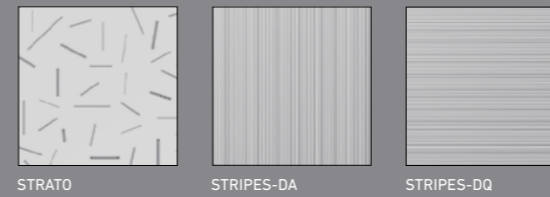

STRATO STRIPES-DA STRIPES-DQ

### KLASSISCHE ORNAMENTGLÄSER | CLASSIC PATTERNED GLASS PANELS



CHINCHILLA WEISS CHINCHILLA WHITE KLARGLAS TRANSPARENT GLASS SATINATO MASTERCARRÉ WEISS MASTERCARRÉ WHITE MASTERLIGNE MASTERPOINT

TOP-BESCHLÄGE | TOP-FERRURE

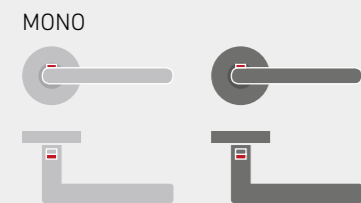

**MONO**  
WÄHLBAR IN EDELSTAHL MATT ODER GRAPHITSCHWARZ  
AVAILABLE IN STAINLESS STEEL MATT OR GRAPHITE BLACK

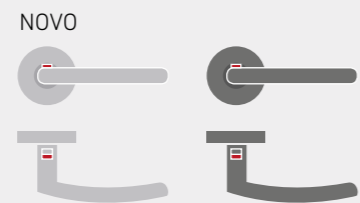

**NOVO**  
WÄHLBAR IN EDELSTAHL MATT ODER GRAPHITSCHWARZ  
AVAILABLE IN STAINLESS STEEL MATT OR GRAPHITE BLACK

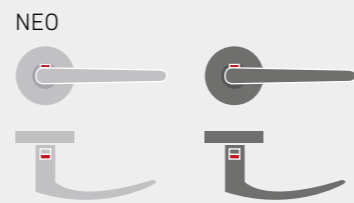

**NEO**  
WÄHLBAR IN EDELSTAHL MATT ODER GRAPHITSCHWARZ  
AVAILABLE IN STAINLESS STEEL MATT OR GRAPHITE BLACK

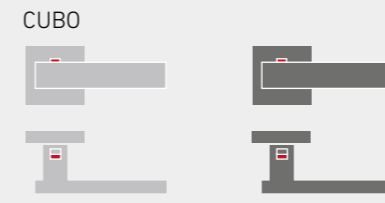

**CUBO**  
WÄHLBAR IN EDELSTAHL MATT ODER GRAPHITSCHWARZ  
AVAILABLE IN STAINLESS STEEL MATT OR GRAPHITE BLACK

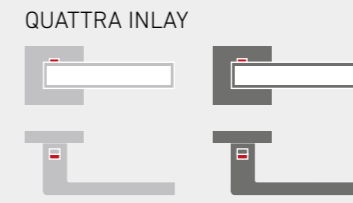

**QUATTRA INLAY**  
WÄHLBAR IN EDELSTAHL OPTIK MATT ODER GRAPHITSCHWARZ  
AVAILABLE IN MATT STAINLESS STEEL LOOK OR GRAPHITE BLACK

INLAYS | INLAYS





# Das DESIGNTÜREN-Programm

## The DESIGN DOOR range

### **RAUM FÜR DESIGN**

Mit den Modellen unseres DESIGNTÜREN-Programms werden Wohnwelten gestaltet.

### **SPACE FOR DESIGN**

The models in our DESIGN DOOR range can be used to create living spaces.





**AURA**  
**Weißlack 9016**

AURA  
White varnish 9016

Starke Inszenierung von Tür und Raum  
mit einzigartiger Ausstrahlung.  
Both the door and the room make a strong  
statement and have unique appeal.



AURA  
Weißlack 9016

## Atmosphäre auf ganzer Linie

Impressive atmosphere

Ausdrucksstark wohnen mit der edlen Design-Kombination aus Weißlack und Glas.  
Enjoy an expressive home environment featuring the exclusive combination of white varnish and glass.

### LISENEN | PILASTER STRIPS

Lisene Matt-Schwarz

Lisene Edelstahloptik

### QUERSCHNITT | CROSS

KLEINE RUNDKANTE | SMALL ROUNDED EDGE



Lichtausschnitt-Türen



geschlossene Türen



BESCHLAG  
QUATTRA INLAY

GRAPHITSCHWARZ  
GRAPHITE BLACK



BB/PZ/WC



smart2lock

EDELSTAHOPTIK MATT  
MATT STAINLESS STEEL LOOK



BB/PZ/WC



smart2lock



<b>MODELL</b>	1 AURA A830
<b>OBERFLÄCHE</b>	Weißlack 9016
<b>GLAS</b>	-
<b>ZARGE</b>	KR1
<b>BESCHLAG</b>	QUATTRA INLAY, Graphitschwarz
<b>MODEL</b>	AURA A830
<b>FINISH</b>	White varnish 9016
<b>GLASS</b>	-
<b>FRAME</b>	KR1
<b>FITTINGS</b>	QUATTRA INLAY, Graphite black

<b>MODELL</b>	2 AURA A830-LA4M
<b>OBERFLÄCHE</b>	Weißlack 9016
<b>GLAS</b>	SATINATO, Standard-Ornamentglas
<b>ZARGE</b>	KR1
<b>BESCHLAG</b>	QUATTRA INLAY, Graphitschwarz
<b>MODEL</b>	AURA A830-LA4M
<b>FINISH</b>	White varnish 9016
<b>GLASS</b>	SATINATO, standard patterned glass
<b>FRAME</b>	KR1
<b>FITTINGS</b>	QUATTRA INLAY, Graphite black

<b>MODELL</b>	3 AURA A834
<b>OBERFLÄCHE</b>	Weißlack 9016
<b>GLAS</b>	-
<b>ZARGE</b>	KR1
<b>BESCHLAG</b>	QUATTRA INLAY, Graphitschwarz
<b>MODEL</b>	AURA A834
<b>FINISH</b>	White varnish 9016
<b>GLASS</b>	-
<b>FRAME</b>	KR1
<b>FITTINGS</b>	QUATTRA INLAY, Graphite black

<b>MODELL</b>	4 AURA A834-LA4S
<b>OBERFLÄCHE</b>	Weißlack 9016
<b>GLAS</b>	SATINATO, Standard-Ornamentglas
<b>ZARGE</b>	KR1
<b>BESCHLAG</b>	QUATTRA INLAY, Graphitschwarz
<b>MODEL</b>	AURA A834-LA4S
<b>FINISH</b>	White varnish 9016
<b>GLASS</b>	SATINATO, standard patterned glass
<b>FRAME</b>	KR1
<b>FITTINGS</b>	QUATTRA INLAY, Graphite black

<b>MODELL</b>	5 AURA A850
<b>OBERFLÄCHE</b>	Weißlack 9016
<b>GLAS</b>	-
<b>ZARGE</b>	KR1
<b>BESCHLAG</b>	QUATTRA INLAY, Edelstahloptik Matt
<b>MODEL</b>	AURA A850
<b>FINISH</b>	White varnish 9016
<b>GLASS</b>	-
<b>FRAME</b>	KR1
<b>FITTINGS</b>	QUATTRA INLAY, Matt stainless steel look

<b>MODELL</b>	6 AURA A851
<b>OBERFLÄCHE</b>	Weißlack 9016
<b>GLAS</b>	-
<b>ZARGE</b>	KR1
<b>BESCHLAG</b>	QUATTRA INLAY, Edelstahloptik Matt
<b>MODEL</b>	AURA A851
<b>FINISH</b>	White varnish 9016
<b>GLASS</b>	-
<b>FRAME</b>	KR1
<b>FITTINGS</b>	QUATTRA INLAY, Matt stainless steel look

<b>MODELL</b>	7 AURA A831
<b>OBERFLÄCHE</b>	Weißlack 9016
<b>GLAS</b>	-
<b>ZARGE</b>	KR1
<b>BESCHLAG</b>	QUATTRA INLAY, Edelstahloptik Matt
<b>MODEL</b>	AURA A831
<b>FINISH</b>	White varnish 9016
<b>GLASS</b>	-
<b>FRAME</b>	KR1
<b>FITTINGS</b>	QUATTRA INLAY, Matt stainless steel look



**JETZT TESTEN**  
Im Online-Türentool „DieTÜR“ von GARANT kombinieren Sie mit einfachen Klicks Ihre individuelle Wunschtür.  
**TEST NOW**  
Use GARANT's online door tool 'DieTÜR' to create your own custom door in just a few clicks.

AURA  
Weißlack 9010

## Elegante Abwechslung An elegant change

Weißer Farbe im reizvollen Kontrast zu Mobiliar und Wohnaccessoires.  
White varnish contrasts beautifully with the furniture and interior design features.

### LISENEN | PILASTER STRIPS

Lisene Matt-Schwarz

Lisene Edelstahloptik

### QUERSCHNITT | CROSS

RUNDKANTE | ROUNDED EDGE

Lichtausschnitt-Türen geschlossene Türen



BESCHLAG  
CUBO

GRAPHITSCHWARZ  
GRAPHITE BLACK

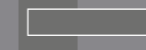

BB/PZ/WC



smart2lock

EDELSTAHL MATT  
STAINLESS STEEL MATT



BB/PZ/WC



smart2lock



<b>MODELL</b>	1 AURA A830
<b>OBERFLÄCHE</b>	Weißlack 9010
<b>GLAS</b>	-
<b>ZARGE</b>	R1
<b>BESCHLAG</b>	CUBO, Graphitschwarz
<b>MODEL</b>	AURA A830
<b>FINISH</b>	White varnish 9010
<b>GLASS</b>	-
<b>FRAME</b>	R1
<b>FITTINGS</b>	CUBO, Graphite black

<b>MODELL</b>	2 AURA A830-LA4M
<b>OBERFLÄCHE</b>	Weißlack 9010
<b>GLAS</b>	SATINATO, Standard-Ornamentglas
<b>ZARGE</b>	R1
<b>BESCHLAG</b>	CUBO, Graphitschwarz
<b>MODEL</b>	AURA A830-LA4M
<b>FINISH</b>	White varnish 9010
<b>GLASS</b>	SATINATO, standard patterned glass
<b>FRAME</b>	R1
<b>FITTINGS</b>	CUBO, Graphite black

<b>MODELL</b>	3 AURA A834
<b>OBERFLÄCHE</b>	Weißlack 9010
<b>GLAS</b>	-
<b>ZARGE</b>	R1
<b>BESCHLAG</b>	CUBO, Graphitschwarz
<b>MODEL</b>	AURA A834
<b>FINISH</b>	White varnish 9010
<b>GLASS</b>	-
<b>FRAME</b>	R1
<b>FITTINGS</b>	CUBO, Graphite black

<b>MODELL</b>	4 AURA A834-LA4S
<b>OBERFLÄCHE</b>	Weißlack 9010
<b>GLAS</b>	SATINATO, Standard-Ornamentglas
<b>ZARGE</b>	R1
<b>BESCHLAG</b>	CUBO, Graphitschwarz
<b>MODEL</b>	AURA A834-LA4S
<b>FINISH</b>	White varnish 9010
<b>GLASS</b>	SATINATO, standard patterned glass
<b>FRAME</b>	R1
<b>FITTINGS</b>	CUBO, Graphite black

<b>MODELL</b>	5 AURA A850
<b>OBERFLÄCHE</b>	Weißlack 9010
<b>GLAS</b>	-
<b>ZARGE</b>	R1
<b>BESCHLAG</b>	CUBO, Edelstahl Matt
<b>MODEL</b>	AURA A850
<b>FINISH</b>	White varnish 9010
<b>GLASS</b>	-
<b>FRAME</b>	R1
<b>FITTINGS</b>	CUBO, Stainless steel matt

<b>MODELL</b>	6 AURA A851
<b>OBERFLÄCHE</b>	Weißlack 9010
<b>GLAS</b>	-
<b>ZARGE</b>	R1
<b>BESCHLAG</b>	CUBO, Edelstahl Matt
<b>MODEL</b>	AURA A851
<b>FINISH</b>	White varnish 9010
<b>GLASS</b>	-
<b>FRAME</b>	R1
<b>FITTINGS</b>	CUBO, Stainless steel matt

<b>MODELL</b>	7 AURA A831
<b>OBERFLÄCHE</b>	Weißlack 9010
<b>GLAS</b>	-
<b>ZARGE</b>	R1
<b>BESCHLAG</b>	CUBO, Edelstahl Matt
<b>MODEL</b>	AURA A831
<b>FINISH</b>	White varnish 9010
<b>GLASS</b>	-
<b>FRAME</b>	R1
<b>FITTINGS</b>	CUBO, Stainless steel matt



**JETZT TESTEN**  
Im Online-Türentool „DieTÜR“ von GARANT kombinieren Sie mit einfachen Klicks Ihre individuelle Wunschtür.  
**TEST NOW**  
Use GARANT's online door tool 'DieTÜR' to create your own custom door in just a few clicks.

# Gesamtübersicht DESIGNTÜREN-Programm

## Overview of the DESIGN DOOR range

AURA | AURA



A310 A830 A830-LA4M A831 A832 A832-LA4M A833 A833-LA4M A834 A834-LA4S A850 A851

OBERFLÄCHEN  
FINISHES



TÜRKANTEN  
EDGES



OBERFLÄCHEN  
FINISHES



TÜRKANTEN  
EDGES



### MODERNE ORNAMENTGLÄSER | MODERN PATTERNED GLASS PANELS

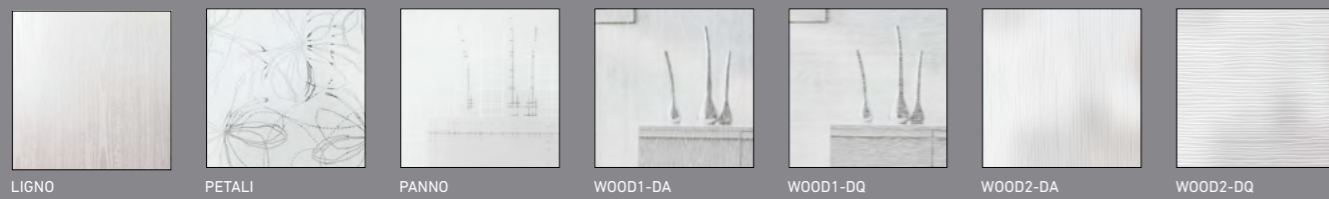

LIGNO PETALI PANNO WOOD1-DA WOOD1-DQ WOOD2-DA WOOD2-DQ

### DESIGNGLÄSER – SIEBDRUCK-VEREDELUNG | DESIGN GLASS PANELS – SCREEN PRINTED DÉCOR

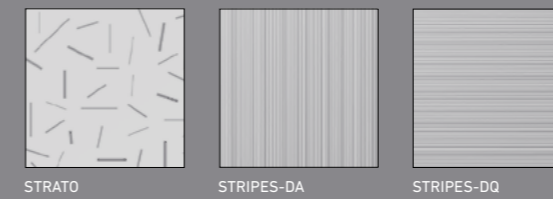

STRATO STRIPES-DA STRIPES-DQ

### KLASSISCHE ORNAMENTGLÄSER | CLASSIC PATTERNED GLASS PANELS



CHINCHILLA WEISS CHINCHILLA WHITE KLARGLAS TRANSPARENT GLASS SATINATO MASTERCARRÉ WEISS MASTERCARRÉ WHITE MASTERLIGNE MASTERPOINT

TOP-BESCHLÄGE | TOP-FERRURE

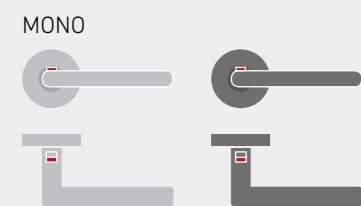

WÄHLBAR IN EDELSTAHL MATT ODER GRAPHITSCHWARZ  
AVAILABLE IN STAINLESS STEEL MATT OR GRAPHITE BLACK

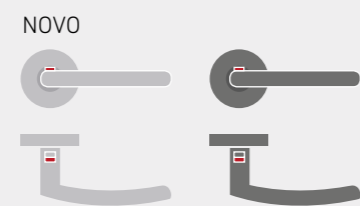

WÄHLBAR IN EDELSTAHL MATT ODER GRAPHITSCHWARZ  
AVAILABLE IN STAINLESS STEEL MATT OR GRAPHITE BLACK

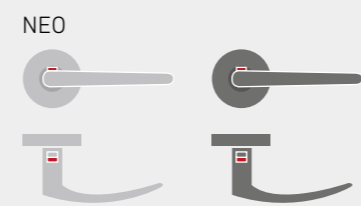

WÄHLBAR IN EDELSTAHL MATT ODER GRAPHITSCHWARZ  
AVAILABLE IN STAINLESS STEEL MATT OR GRAPHITE BLACK

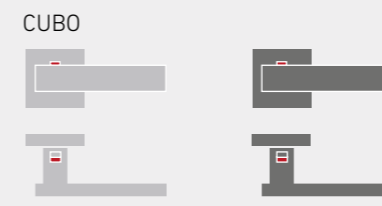

WÄHLBAR IN EDELSTAHL MATT ODER GRAPHITSCHWARZ  
AVAILABLE IN STAINLESS STEEL MATT OR GRAPHITE BLACK

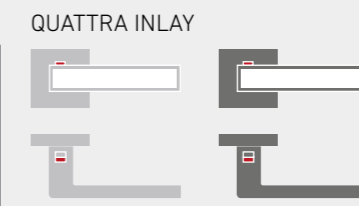

WÄHLBAR IN EDELSTAHL OPTIK MATT ODER GRAPHITSCHWARZ  
AVAILABLE IN MATT STAINLESS STEEL LOOK OR GRAPHITE BLACK

INLAYS | INLAYS

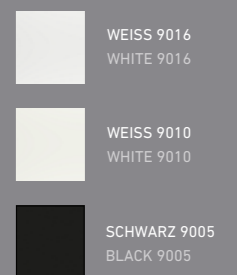

# Das PROFILTÜREN-Programm

The PROFILE DOOR range

## **TRÄUME IN WEISS ERLEBEN:**

Unsere PROFILTÜREN mit edlen Weißlackoberflächen.

## **EXPERIENCE DREAMS IN WHITE:**

our PROFILE DOORS with elegant white varnish finishes.





**MILANO**  
**Weißlack 9016**

MILANO  
White varnish 9016

Mit Leichtigkeit und Profil ganz selbstverständlich inszeniert.

A convincingly light design featuring profiled sections.





MILANO  
Weißlack 9016

## Eine Optik mit Mehrwert Value-adding aesthetics

Lichtausschnitt-Modelle begeistern durch eine flächenbündige Glasleiste.  
The models with vision panels feature a flush-fitted glass strip.

### QUERSCHNITT | CROSS

KLEINE RUNDKANTE | SMALL ROUNDED EDGE

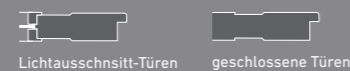

BESCHLAG  
NOVO

GRAPHITSCHWARZ  
GRAPHITE BLACK



BB/PZ/WC



smart2lock

EDELSTAHL MATT  
STAINLESS STEEL MATT



BB/PZ/WC



smart2lock



<b>MODELL</b>	1 MILANO M3/2
<b>OBERFLÄCHE</b>	Weißlack 9016
<b>GLAS</b>	-
<b>ZARGE</b>	KR1
<b>BESCHLAG</b>	NOVO, Graphitschwarz
<b>MODEL</b>	MILANO M3/2
<b>FINISH</b>	White varnish 9016
<b>GLASS</b>	-
<b>FRAME</b>	KR1
<b>FITTINGS</b>	NOVO, Graphite black

<b>MODELL</b>	2 MILANO ML3/2
<b>OBERFLÄCHE</b>	Weißlack 9016
<b>GLAS</b>	SATINATO, Standard-Ornamentglas
<b>ZARGE</b>	KR1
<b>BESCHLAG</b>	NOVO, Graphitschwarz
<b>MODEL</b>	MILANO ML3/2
<b>FINISH</b>	White varnish 9016
<b>GLASS</b>	SATINATO, standard patterned glass
<b>FRAME</b>	KR1
<b>FITTINGS</b>	NOVO, Graphite black

<b>MODELL</b>	3 MILANO ML2/1
<b>OBERFLÄCHE</b>	Weißlack 9016
<b>GLAS</b>	SATINATO, Standard-Ornamentglas
<b>ZARGE</b>	KR1
<b>BESCHLAG</b>	NOVO, Graphitschwarz
<b>MODEL</b>	MILANO ML2/1
<b>FINISH</b>	White varnish 9016
<b>GLASS</b>	SATINATO, standard patterned glass
<b>FRAME</b>	KR1
<b>FITTINGS</b>	NOVO, Graphite black

<b>MODELL</b>	4 MILANO M2
<b>OBERFLÄCHE</b>	Weißlack 9016
<b>GLAS</b>	-
<b>ZARGE</b>	KR1
<b>BESCHLAG</b>	NOVO, Graphitschwarz
<b>MODEL</b>	MILANO M2
<b>FINISH</b>	White varnish 9016
<b>GLASS</b>	-
<b>FRAME</b>	KR1
<b>FITTINGS</b>	NOVO, Graphite black

<b>MODELL</b>	5 MILANO ML2
<b>OBERFLÄCHE</b>	Weißlack 9016
<b>GLAS</b>	SATINATO, Standard-Ornamentglas
<b>ZARGE</b>	KR1
<b>BESCHLAG</b>	NOVO, Edelstahl Matt
<b>MODEL</b>	MILANO ML2
<b>FINISH</b>	White varnish 9016
<b>GLASS</b>	SATINATO, standard patterned glass
<b>FRAME</b>	KR1
<b>FITTINGS</b>	NOVO, Stainless steel matt

<b>MODELL</b>	6 MILANO M1
<b>OBERFLÄCHE</b>	Weißlack 9016
<b>GLAS</b>	-
<b>ZARGE</b>	KR1
<b>BESCHLAG</b>	NOVO, Edelstahl Matt
<b>MODEL</b>	MILANO M1
<b>FINISH</b>	White varnish 9016
<b>GLASS</b>	-
<b>FRAME</b>	KR1
<b>FITTINGS</b>	NOVO, Stainless steel matt

<b>MODELL</b>	7 MILANO ML1
<b>OBERFLÄCHE</b>	Weißlack 9016
<b>GLAS</b>	WOOD2-DQ, Design-Ornamentglas
<b>ZARGE</b>	KR1
<b>BESCHLAG</b>	NOVO, Edelstahl Matt
<b>MODEL</b>	MILANO ML1
<b>FINISH</b>	White varnish 9016
<b>GLASS</b>	WOOD2-DQ, design patterned glass
<b>FRAME</b>	KR1
<b>FITTINGS</b>	NOVO, Stainless steel matt



**JETZT TESTEN**  
Im Online-Türentool „DieTÜR“ von GARANT kombinieren Sie mit einfachen Klicks Ihre individuelle Wunschtür.  
**TEST NOW**  
Use GARANT's online door tool "DieTÜR" to create your own custom door in just a few clicks.





MILANO  
Weißlack 9010

## Ausgezeichneter Geschmack Excellent taste

Mit den Weißlacktüren MILANO Formgefühl beweisen.  
The MILANO white varnish doors boast a harmonious design.

### QUERSCHNITT | CROSS

RUNDKANTE | ROUNDED EDGE

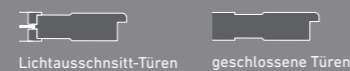

BESCHLAG  
NEO

GRAPHITSCHWARZ  
GRAPHITE BLACK



BB/PZ/WC



smart2lock

EDELSTAHL MATT  
STAINLESS STEEL MATT



BB/PZ/WC



smart2lock



<b>MODELL</b>	1 MILANO M3/2
<b>OBERFLÄCHE</b>	Weißlack 9010
<b>GLAS</b>	-
<b>ZARGE</b>	R1
<b>BESCHLAG</b>	NEO, Graphitschwarz
<b>MODEL</b>	MILANO M3/2
<b>FINISH</b>	White varnish 9010
<b>GLASS</b>	-
<b>FRAME</b>	R1
<b>FITTINGS</b>	NEO, Graphite black

<b>MODELL</b>	2 MILANO ML3/2
<b>OBERFLÄCHE</b>	Weißlack 9010
<b>GLAS</b>	SATINATO, Standard-Ornamentglas
<b>ZARGE</b>	R1
<b>BESCHLAG</b>	NEO, Graphitschwarz
<b>MODEL</b>	MILANO ML3/2
<b>FINISH</b>	White varnish 9010
<b>GLASS</b>	SATINATO, standard patterned glass
<b>FRAME</b>	R1
<b>FITTINGS</b>	NEO, Graphite black

<b>MODELL</b>	3 MILANO M2/1
<b>OBERFLÄCHE</b>	Weißlack 9010
<b>GLAS</b>	-
<b>ZARGE</b>	R1
<b>BESCHLAG</b>	NEO, Graphitschwarz
<b>MODEL</b>	MILANO M2/1
<b>FINISH</b>	White varnish 9010
<b>GLASS</b>	-
<b>FRAME</b>	R1
<b>FITTINGS</b>	NEO, Graphite black

<b>MODELL</b>	4 MILANO M2
<b>OBERFLÄCHE</b>	Weißlack 9010
<b>GLAS</b>	-
<b>ZARGE</b>	R1
<b>BESCHLAG</b>	NEO, Graphitschwarz
<b>MODEL</b>	MILANO M2
<b>FINISH</b>	White varnish 9010
<b>GLASS</b>	-
<b>FRAME</b>	R1
<b>FITTINGS</b>	NEO, Graphite black

<b>MODELL</b>	5 MILANO ML2
<b>OBERFLÄCHE</b>	Weißlack 9010
<b>GLAS</b>	SATINATO, Standard-Ornamentglas
<b>ZARGE</b>	R1
<b>BESCHLAG</b>	NEO, Edelstahl Matt
<b>MODEL</b>	MILANO ML2
<b>FINISH</b>	White varnish 9010
<b>GLASS</b>	SATINATO, standard patterned glass
<b>FRAME</b>	R1
<b>FITTINGS</b>	NEO, Stainless steel matt

<b>MODELL</b>	6 MILANO M1
<b>OBERFLÄCHE</b>	Weißlack 9010
<b>GLAS</b>	-
<b>ZARGE</b>	R1
<b>BESCHLAG</b>	NEO, Edelstahl Matt
<b>MODEL</b>	MILANO M1
<b>FINISH</b>	White varnish 9010
<b>GLASS</b>	-
<b>FRAME</b>	R1
<b>FITTINGS</b>	NEO, Stainless steel matt

<b>MODELL</b>	7 MILANO ML1
<b>OBERFLÄCHE</b>	Weißlack 9010
<b>GLAS</b>	PETALI, Design-Ornamentglas
<b>ZARGE</b>	R1
<b>BESCHLAG</b>	NEO, Edelstahl Matt
<b>MODEL</b>	MILANO ML1
<b>FINISH</b>	White varnish 9010
<b>GLASS</b>	PETALI, design patterned glass
<b>FRAME</b>	R1
<b>FITTINGS</b>	NEO, Stainless steel matt



**JETZT TESTEN**  
Im Online-Türentool „DieTÜR“ von GARANT kombinieren Sie mit einfachen Klicks Ihre individuelle Wunschtür.  
**TEST NOW**  
Use GARANT's online door tool "DieTÜR" to create your own custom door in just a few clicks.

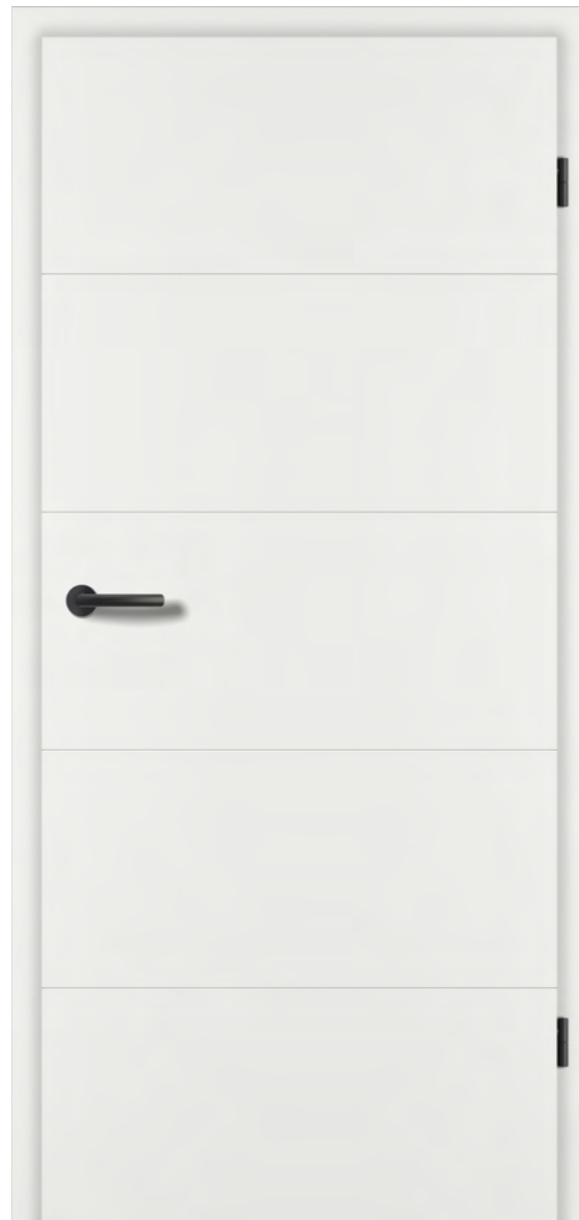

**RIVA**  
**Weißlack 9016**

RIVA  
White varnish 9016

Hochwertige Weißlacktüren für eine vielseitige  
und hochwertige Raumgestaltung.

Premium quality white varnish doors for  
versatile premium interior design.



RIVA  
Weißlack 9016

## Akzente für jede Raumgestaltung

Stylish highlights  
for every room

Türen für eine individuelle Note.  
Doors that add a personal touch.

### QUERSCHNITT | CROSS

KLEINE RUNDKANTE | SMALL ROUNDED EDGE



BESCHLAG  
NOVO

GRAPHITSCHWARZ  
GRAPHITE BLACK



BB/PZ/WC



smart2lock

EDELSTAHL MATT  
STAINLESS STEEL MATT



BB/PZ/WC



smart2lock

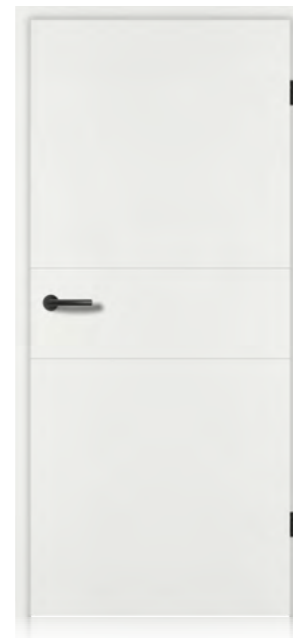

<b>MODELL</b>	1 RIVA R11
<b>OBERFLÄCHE</b>	Weißlack 9016
<b>GLAS</b>	-
<b>ZARGE</b>	KR1
<b>BESCHLAG</b>	NOVO, Graphitschwarz
<b>MODEL</b>	RIVA R11
<b>FINISH</b>	White varnish 9016
<b>GLASS</b>	-
<b>FRAME</b>	KR1
<b>FITTINGS</b>	NOVO, Graphite black

<b>MODELL</b>	2 RIVA R11-LA4S
<b>OBERFLÄCHE</b>	Weißlack 9016
<b>GLAS</b>	SATINATO, Standard-Ornamentglas
<b>ZARGE</b>	KR1
<b>BESCHLAG</b>	NOVO, Graphitschwarz
<b>MODEL</b>	RIVA R11-LA4S
<b>FINISH</b>	White varnish 9016
<b>GLASS</b>	SATINATO, standard patterned glass
<b>FRAME</b>	KR1
<b>FITTINGS</b>	NOVO, Graphite black

<b>MODELL</b>	3 RIVA R18
<b>OBERFLÄCHE</b>	Weißlack 9016
<b>GLAS</b>	-
<b>ZARGE</b>	KR1
<b>BESCHLAG</b>	NOVO, Graphitschwarz
<b>MODEL</b>	RIVA R18
<b>FINISH</b>	White varnish 9016
<b>GLASS</b>	-
<b>FRAME</b>	KR1
<b>FITTINGS</b>	NOVO, Graphite black

<b>MODELL</b>	4 RIVA R18-LA4M
<b>OBERFLÄCHE</b>	Weißlack 9016
<b>GLAS</b>	SATINATO, Standard-Ornamentglas
<b>ZARGE</b>	KR1
<b>BESCHLAG</b>	NOVO, Graphitschwarz
<b>MODEL</b>	RIVA R18-LA4M
<b>FINISH</b>	White varnish 9016
<b>GLASS</b>	SATINATO, standard patterned glass
<b>FRAME</b>	KR1
<b>FITTINGS</b>	NOVO, Graphite black

<b>MODELL</b>	5 RIVA R14
<b>OBERFLÄCHE</b>	Weißlack 9016
<b>GLAS</b>	-
<b>ZARGE</b>	KR1
<b>BESCHLAG</b>	NOVO, Edelstahl Matt
<b>MODEL</b>	RIVA R14
<b>FINISH</b>	White varnish 9016
<b>GLASS</b>	-
<b>FRAME</b>	KR1
<b>FITTINGS</b>	NOVO, Stainless steel matt

<b>MODELL</b>	6 RIVA R11
<b>OBERFLÄCHE</b>	Weißlack 9016
<b>GLAS</b>	-
<b>ZARGE</b>	KR1
<b>BESCHLAG</b>	NOVO, Edelstahl Matt
<b>MODEL</b>	RIVA R11
<b>FINISH</b>	White varnish 9016
<b>GLASS</b>	-
<b>FRAME</b>	KR1
<b>FITTINGS</b>	NOVO, Stainless steel matt

<b>MODELL</b>	7 RIVA R11-LA2
<b>OBERFLÄCHE</b>	Weißlack 9016
<b>GLAS</b>	STRIPES DA, Siebdruck-Veredelung
<b>ZARGE</b>	KR1
<b>BESCHLAG</b>	NOVO, Edelstahl Matt
<b>MODEL</b>	RIVA R11-LA2
<b>FINISH</b>	White varnish 9016
<b>GLASS</b>	STRIPES DA, screen printed décor
<b>FRAME</b>	KR1
<b>FITTINGS</b>	NOVO, Stainless steel matt



**JETZT TESTEN**  
Im Online-Türentool „DieTÜR“ von GARANT kombinieren Sie mit einfachen Klicks Ihre individuelle Wunschtür.  
**TEST NOW**  
Use GARANT's online door tool 'DieTÜR' to create your own custom door in just a few clicks.

RIVA  
Weißlack 9010

## Unbeschwertes Lebensgefühl Carefree living

Klare Linienführung plus klare Details für ein starkes Gesamtbild.  
Clear lines and clear details make a powerful statement.

### QUERSCHNITT | CROSS

RUNDKANTE | ROUNDED EDGE



### BESCHLAG QUATTRA INLAY

GRAPHITSCHWARZ  
GRAPHITE BLACK



BB/PZ/WC



smart2lock

EDELSTAHOPTIK MATT  
MATT STAINLESS STEEL LOOK



BB/PZ/WC



smart2lock



<b>MODELL</b>	1 RIVA R11
<b>OBERFLÄCHE</b>	Weißlack 9010
<b>GLAS</b>	-
<b>ZARGE</b>	R1
<b>BESCHLAG</b>	QUATTRA INLAY, Graphitschwarz
<b>MODEL</b>	RIVA R11
<b>FINISH</b>	White varnish 9010
<b>GLASS</b>	-
<b>FRAME</b>	R1
<b>FITTINGS</b>	QUATTRA INLAY, Graphite black

<b>MODELL</b>	2 RIVA R11-LA4S
<b>OBERFLÄCHE</b>	Weißlack 9010
<b>GLAS</b>	SATINATO, Standard-Ornamentglas
<b>ZARGE</b>	R1
<b>BESCHLAG</b>	QUATTRA INLAY, Graphitschwarz
<b>MODEL</b>	RIVA R11-LA4S
<b>FINISH</b>	White varnish 9010
<b>GLASS</b>	SATINATO, standard patterned glass
<b>FRAME</b>	R1
<b>FITTINGS</b>	QUATTRA INLAY, Graphite black

<b>MODELL</b>	3 RIVA R18
<b>OBERFLÄCHE</b>	Weißlack 9010
<b>GLAS</b>	-
<b>ZARGE</b>	R1
<b>BESCHLAG</b>	QUATTRA INLAY, Graphitschwarz
<b>MODEL</b>	RIVA R18
<b>FINISH</b>	White varnish 9010
<b>GLASS</b>	-
<b>FRAME</b>	R1
<b>FITTINGS</b>	QUATTRA INLAY, Graphite black

<b>MODELL</b>	4 RIVA R18-LA4M
<b>OBERFLÄCHE</b>	Weißlack 9010
<b>GLAS</b>	SATINATO, Standard-Ornamentglas
<b>ZARGE</b>	R1
<b>BESCHLAG</b>	QUATTRA INLAY, Graphitschwarz
<b>MODEL</b>	RIVA R18-LA4M
<b>FINISH</b>	White varnish 9010
<b>GLASS</b>	SATINATO, standard patterned glass
<b>FRAME</b>	R1
<b>FITTINGS</b>	QUATTRA INLAY, Graphite black

<b>MODELL</b>	5 RIVA R14
<b>OBERFLÄCHE</b>	Weißlack 9010
<b>GLAS</b>	-
<b>ZARGE</b>	R1
<b>BESCHLAG</b>	QUATTRA INLAY, Edelstahloptik Matt
<b>MODEL</b>	RIVA R14
<b>FINISH</b>	White varnish 9010
<b>GLASS</b>	-
<b>FRAME</b>	R1
<b>FITTINGS</b>	QUATTRA INLAY, Matt stainless steel look

<b>MODELL</b>	6 RIVA R111
<b>OBERFLÄCHE</b>	Weißlack 9010
<b>GLAS</b>	-
<b>ZARGE</b>	R1
<b>BESCHLAG</b>	QUATTRA INLAY, Edelstahloptik Matt
<b>MODEL</b>	RIVA R111
<b>FINISH</b>	White varnish 9010
<b>GLASS</b>	-
<b>FRAME</b>	R1
<b>FITTINGS</b>	QUATTRA INLAY, Matt stainless steel look

<b>MODELL</b>	7 RIVA R111-LA2
<b>OBERFLÄCHE</b>	Weißlack 9010
<b>GLAS</b>	STRATO, Siebdruck-Veredelung
<b>ZARGE</b>	R1
<b>BESCHLAG</b>	QUATTRA INLAY, Edelstahloptik Matt
<b>MODEL</b>	RIVA R111-LA2
<b>FINISH</b>	White varnish 9010
<b>GLASS</b>	STRATO, screen printed décor
<b>FRAME</b>	R1
<b>FITTINGS</b>	QUATTRA INLAY, Matt stainless steel look



**JETZT TESTEN**  
Im Online-Türentool „DieTÜR“ von GARANT kombinieren Sie mit einfachen Klicks Ihre individuelle Wunschtür.  
**TEST NOW**  
Use GARANT's online door tool 'DieTÜR' to create your own custom door in just a few clicks.



**COMO**  
**Weißlack 9016**

COMO  
White varnish 9016

Das Plus für jeden Raum: Klassisch und modern,  
zurückhaltend und stilsicher.

It enhances any room: classic and modern,  
understated or stylish.



COMO  
Weißlack 9016

## Vielseitig elegant Elegant versatility

Zeitlose Kassettenoptik unterstreicht die Schönheit der Einrichtung.  
A timeless panelled look underlines the beauty of the interior furnishings.

### QUERSCHNITT | CROSS

KLEINE RUNDKANTE | SMALL ROUNDED EDGE



### BESCHLAG MONO

GRAPHITSCHWARZ  
GRAPHITE BLACK



BB/PZ/WC



smart2lock

EDELSTAHL MATT  
STAINLESS STEEL MATT



BB/PZ/WC



smart2lock



<b>MODELL</b>	1	COMO CK3
<b>OBERFLÄCHE</b>		Weißlack 9016
<b>GLAS</b>		-
<b>ZARGE</b>		KR1
<b>BESCHLAG</b>		MONO, Graphitschwarz
<b>MODEL</b>		COMO CK3
<b>FINISH</b>		White varnish 9016
<b>GLASS</b>		-
<b>FRAME</b>		KR1
<b>FITTINGS</b>		MONO, Graphite black

<b>MODELL</b>	2	COMO CKL3+SP4
<b>OBERFLÄCHE</b>		Weißlack 9016
<b>GLAS</b>		SATINATO, Standard-Ornamentglas
<b>ZARGE</b>		KR1
<b>BESCHLAG</b>		MONO, Graphitschwarz
<b>MODEL</b>		COMO CKL3+SP4
<b>FINISH</b>		White varnish 9016
<b>GLASS</b>		SATINATO, standard patterned glass
<b>FRAME</b>		KR1
<b>FITTINGS</b>		MONO, Graphite black

<b>MODELL</b>	3	COMO CK4
<b>OBERFLÄCHE</b>		Weißlack 9016
<b>GLAS</b>		-
<b>ZARGE</b>		KR1
<b>BESCHLAG</b>		MONO, Graphitschwarz
<b>MODEL</b>		COMO CK4
<b>FINISH</b>		White varnish 9016
<b>GLASS</b>		-
<b>FRAME</b>		KR1
<b>FITTINGS</b>		MONO, Graphite black

<b>MODELL</b>	4	COMO CKL4
<b>OBERFLÄCHE</b>		Weißlack 9016
<b>GLAS</b>		SATINATO, Standard-Ornamentglas
<b>ZARGE</b>		KR1
<b>BESCHLAG</b>		MONO, Graphitschwarz
<b>MODEL</b>		COMO CKL4
<b>FINISH</b>		White varnish 9016
<b>GLASS</b>		SATINATO, standard patterned glass
<b>FRAME</b>		KR1
<b>FITTINGS</b>		MONO, Graphite black

<b>MODELL</b>	5	COMO CKL4/2
<b>OBERFLÄCHE</b>		Weißlack 9016
<b>GLAS</b>		SATINATO, Standard-Ornamentglas
<b>ZARGE</b>		KR1
<b>BESCHLAG</b>		MONO, Graphitschwarz
<b>MODEL</b>		COMO CKL4/2
<b>FINISH</b>		White varnish 9016
<b>GLASS</b>		SATINATO, standard patterned glass
<b>FRAME</b>		KR1
<b>FITTINGS</b>		MONO, Stainless steel matt

<b>MODELL</b>	6	COMO C2
<b>OBERFLÄCHE</b>		Weißlack 9016
<b>GLAS</b>		-
<b>ZARGE</b>		KR1
<b>BESCHLAG</b>		MONO, Edelstahl Matt
<b>MODEL</b>		COMO C2
<b>FINISH</b>		White varnish 9016
<b>GLASS</b>		-
<b>FRAME</b>		KR1
<b>FITTINGS</b>		MONO, Stainless steel matt

<b>MODELL</b>	7	COMO CL2
<b>OBERFLÄCHE</b>		Weißlack 9016
<b>GLAS</b>		WOOD1-DA, Design-Ornamentglas
<b>ZARGE</b>		KR1
<b>BESCHLAG</b>		MONO, Edelstahl Matt
<b>MODEL</b>		COMO CL2
<b>FINISH</b>		White varnish 9016
<b>GLASS</b>		WOOD1-DA, design patterned glass
<b>FRAME</b>		KR1
<b>FITTINGS</b>		MONO, Stainless steel matt



**JETZT TESTEN**  
Im Online-Türentool „DieTÜR“ von GARANT kombinieren Sie mit einfachen Klicks Ihre individuelle Wunschtür.  
**TEST NOW**  
Use GARANT's online door tool 'DieTÜR' to create your own custom door in just a few clicks.



COMO  
Weißlack 9010

Vielseitig schön  
Beautiful versatility

Klassisches Weiß für eine harmonische Raumausstattung.  
Classic white for a harmonious interior design concept.

BESCHLAG  
NEO

GRAPHITSCHWARZ  
GRAPHITE BLACK



BB/PZ/WC



smart2lock

EDELSTAHL MATT  
STAINLESS STEEL MATT



BB/PZ/WC



smart2lock

QUERSCHNITT | CROSS

RUNDKANTE | ROUNDED EDGE



Lichtausschnitt-Türen



geschlossene Türen



44



45



<b>MODELL</b>	1	COMO CK3
<b>OBERFLÄCHE</b>		Weißlack 9010
<b>GLAS</b>		-
<b>ZARGE</b>		R1
<b>BESCHLAG</b>		NEO, Graphitschwarz
<b>MODEL</b>		COMO CK3
<b>FINISH</b>		White varnish 9010
<b>GLASS</b>		-
<b>FRAME</b>		R1
<b>FITTINGS</b>		NEO, Graphite black

<b>MODELL</b>	2	COMO CKL3+SP4
<b>OBERFLÄCHE</b>		Weißlack 9010
<b>GLAS</b>		SATINATO, Standard-Ornamentglas
<b>ZARGE</b>		R1
<b>BESCHLAG</b>		NEO, Graphitschwarz
<b>MODEL</b>		COMO CKL3+SP4
<b>FINISH</b>		White varnish 9010
<b>GLASS</b>		SATINATO, standard patterned glass
<b>FRAME</b>		R1
<b>FITTINGS</b>		NEO, Graphite black

<b>MODELL</b>	3	COMO CK4
<b>OBERFLÄCHE</b>		Weißlack 9010
<b>GLAS</b>		-
<b>ZARGE</b>		R1
<b>BESCHLAG</b>		NEO, Graphitschwarz
<b>MODEL</b>		COMO CK4
<b>FINISH</b>		White varnish 9010
<b>GLASS</b>		-
<b>FRAME</b>		R1
<b>FITTINGS</b>		NEO, Graphite black

<b>MODELL</b>	4	COMO CKL4
<b>OBERFLÄCHE</b>		Weißlack 9010
<b>GLAS</b>		SATINATO, Standard-Ornamentglas
<b>ZARGE</b>		R1
<b>BESCHLAG</b>		NEO, Graphitschwarz
<b>MODEL</b>		COMO CKL4
<b>FINISH</b>		White varnish 9010
<b>GLASS</b>		SATINATO, standard patterned glass
<b>FRAME</b>		R1
<b>FITTINGS</b>		NEO, Graphite black

<b>MODELL</b>	5	COMO CKL4/2
<b>OBERFLÄCHE</b>		Weißlack 9010
<b>GLAS</b>		SATINATO, Standard-Ornamentglas
<b>ZARGE</b>		R1
<b>BESCHLAG</b>		NEO, Edelstahl Matt
<b>MODEL</b>		COMO CKL4/2
<b>FINISH</b>		White varnish 9010
<b>GLASS</b>		SATINATO, standard patterned glass
<b>FRAME</b>		R1
<b>FITTINGS</b>		NEO, Stainless steel matt

<b>MODELL</b>	6	COMO C2
<b>OBERFLÄCHE</b>		Weißlack 9010
<b>GLAS</b>		-
<b>ZARGE</b>		R1
<b>BESCHLAG</b>		NEO, Edelstahl Matt
<b>MODEL</b>		COMO C2
<b>FINISH</b>		White varnish 9010
<b>GLASS</b>		-
<b>FRAME</b>		R1
<b>FITTINGS</b>		NEO, Stainless steel matt

<b>MODELL</b>	7	COMO CL2
<b>OBERFLÄCHE</b>		Weißlack 9010
<b>GLAS</b>		LIGNO, Design-Ornamentglas
<b>ZARGE</b>		R1
<b>BESCHLAG</b>		NEO, Edelstahl Matt
<b>MODEL</b>		COMO CL2
<b>FINISH</b>		White varnish 9010
<b>GLASS</b>		LIGNO, design patterned glass
<b>FRAME</b>		R1
<b>FITTINGS</b>		NEO, Stainless steel matt



**JETZT TESTEN**  
Im Online-Türentool „DieTÜR“ von GARANT kombinieren Sie mit einfachen Klicks Ihre individuelle Wunschtür.  
**TEST NOW**  
Use GARANT's online door tool 'DieTÜR' to create your own custom door in just a few clicks.



**PARMA**  
**Weißlack 9016**

PARMA  
White varnish 9016

Das Leben jeden Tag genießen –  
mit edlen Weißlack-PROFILTÜREN.

Enjoy life every day –  
with the beautiful white varnish PROFILE DOORS.







PARMA  
Weißlack 9016

## Elegante Harmonie

Elegant harmony

Mit PARMA-Weißlacktüren für eine einheitlich angenehme Wohnatmosphäre sorgen.  
The PARMA white varnish doors contribute to a pleasant and harmonious living environment.

### QUERSCHNITT | CROSS

KLEINE RUNDKANTE | SMALL ROUNDED EDGE

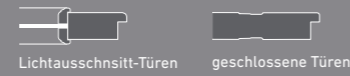

### BESCHLAG NEO

GRAPHITSCHWARZ  
GRAPHITE BLACK



BB/PZ/WC



smart2lock

EDELSTAHL MATT  
STAINLESS STEEL MATT



BB/PZ/WC



smart2lock



<b>MODELL</b>	1 PARMA PF3
<b>OBERFLÄCHE</b>	Weißlack 9016
<b>GLAS</b>	-
<b>ZARGE</b>	KR1
<b>BESCHLAG</b>	NEO, Graphitschwarz
<b>MODEL</b>	PARMA PF1
<b>FINISH</b>	White varnish 3016
<b>GLASS</b>	-
<b>FRAME</b>	KR1
<b>FITTINGS</b>	NEO, Graphite black

<b>MODELL</b>	2 PARMA PF4
<b>OBERFLÄCHE</b>	Weißlack 9016
<b>GLAS</b>	-
<b>ZARGE</b>	KR1
<b>BESCHLAG</b>	NEO, Graphitschwarz
<b>MODEL</b>	PARMA PF4
<b>FINISH</b>	White varnish 9016
<b>GLASS</b>	-
<b>FRAME</b>	KR1
<b>FITTINGS</b>	NEO, Graphite black

<b>MODELL</b>	3 PARMA PFL4
<b>OBERFLÄCHE</b>	Weißlack 9016
<b>GLAS</b>	SATINATO, Standard-Ornamentglas
<b>ZARGE</b>	KR1
<b>BESCHLAG</b>	NEO, Graphitschwarz
<b>MODEL</b>	PARMA PFL4
<b>FINISH</b>	White varnish 9016
<b>GLASS</b>	SATINATO, standard patterned glass
<b>FRAME</b>	KR1
<b>FITTINGS</b>	NEO, Graphite black

<b>MODELL</b>	4 PARMA PFL4+SP4
<b>OBERFLÄCHE</b>	Weißlack 9016
<b>GLAS</b>	SATINATO, Standard-Ornamentglas
<b>ZARGE</b>	KR1
<b>BESCHLAG</b>	NEO, Graphitschwarz
<b>MODEL</b>	PARMA PFL4+SP4
<b>FINISH</b>	White varnish 9016
<b>GLASS</b>	SATINATO, standard patterned glass
<b>FRAME</b>	KR1
<b>FITTINGS</b>	NEO, Graphite black

<b>MODELL</b>	5 PARMA PFL4/2
<b>OBERFLÄCHE</b>	Weißlack 9016
<b>GLAS</b>	SATINATO, Standard-Ornamentglas
<b>ZARGE</b>	KR1
<b>BESCHLAG</b>	NEO, Edelstahl Matt
<b>MODEL</b>	PARMA PFL4/2
<b>FINISH</b>	White varnish 9016
<b>GLASS</b>	SATINATO, standard patterned glass
<b>FRAME</b>	KR1
<b>FITTINGS</b>	NEO, Stainless steel matt

<b>MODELL</b>	6 PARMA PF5
<b>OBERFLÄCHE</b>	Weißlack 9016
<b>GLAS</b>	-
<b>ZARGE</b>	KR1
<b>BESCHLAG</b>	NEO, Edelstahl Matt
<b>MODEL</b>	PARMA PFL5
<b>FINISH</b>	White varnish 9016
<b>GLASS</b>	-
<b>FRAME</b>	KR1
<b>FITTINGS</b>	NEO, Stainless steel matt

<b>MODELL</b>	7 PARMA PFL5
<b>OBERFLÄCHE</b>	Weißlack 9016
<b>GLAS</b>	WOOD1-DQ, Design-Ornamentglas
<b>ZARGE</b>	KR1
<b>BESCHLAG</b>	NEO, Edelstahl Matt
<b>MODEL</b>	PARMA PFL5
<b>FINISH</b>	White varnish 9016
<b>GLASS</b>	WOOD1-DQ, design patterned glass
<b>FRAME</b>	KR1
<b>FITTINGS</b>	NEO, Stainless steel matt



**JETZT TESTEN**  
Im Online-Türentool „DieTÜR“ von GARANT kombinieren Sie mit einfachen Klicks Ihre individuelle Wunschtür.  
**TEST NOW**  
Use GARANT's online door tool 'DieTÜR' to create your own custom door in just a few clicks.

PARMA  
 Weißlack 9010

Lebensfreude pur  
 Pure joie de vivre

Ein Genuss: Die perfekten Türen für jeden Wohnraum.  
 These doors are perfect for any living space and a pleasure to see.

BESCHLAG  
 CUBO

GRAPHITSCHWARZ  
 GRAPHITE BLACK

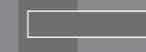

BB/PZ/WC



smart2lock

EDELSTAHL MATT  
 STAINLESS STEEL MATT



BB/PZ/WC



smart2lock

QUERSCHNITT | CROSS

RUNDKANTE | ROUNDED EDGE



Lichtauschnitt-Türen



geschlossene Türen



**MODELL**  
**OBERFLÄCHE**  
**GLAS**  
**ZARGE**  
**BESCHLAG**  
**MODEL**  
**FINISH**  
**GLASS**  
**FRAME**  
**FITTINGS**

1 PARMA PF3  
 Weißlack 9010

2 PARMA PF4  
 Weißlack 9010

3 PARMA PFL4  
 Weißlack 9010  
 SATINATO, Standard-Ornamentglas  
 R1

4 PARMA PFL4+SP4  
 Weißlack 9010  
 SATINATO, Standard-Ornamentglas  
 R1

5 PARMA PFL4/2  
 Weißlack 9010  
 SATINATO, Standard-Ornamentglas  
 R1

6 PARMA PF5  
 Weißlack 9010

7 PARMA PFL5  
 Weißlack 9010  
 PANNO, Design-Ornamentglas  
 R1



**JETZT TESTEN**  
 Im Online-Türentool „DieTÜR“ von GARANT kombinieren Sie mit einfachen Klicks Ihre individuelle Wunschtür.  
**TEST NOW**  
 Use GARANT's online door tool 'DieTÜR' to create your own custom door in just a few clicks.

# Gesamtübersicht PROFILTÜREN-Programm

## Overview of the PROFILE DOOR range

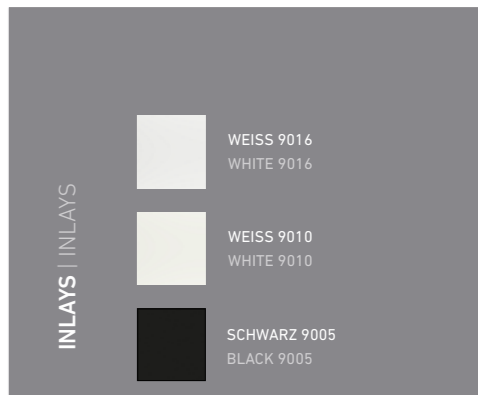
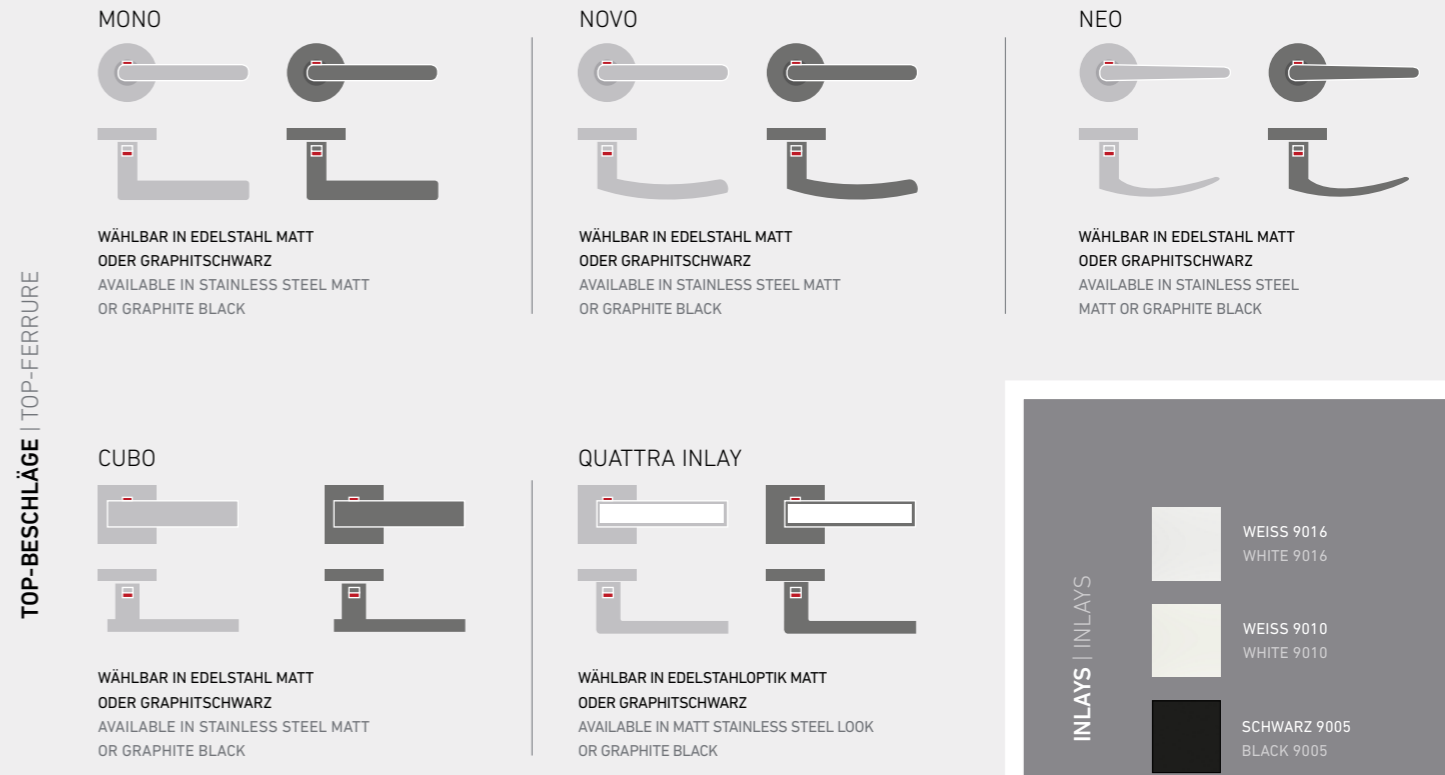
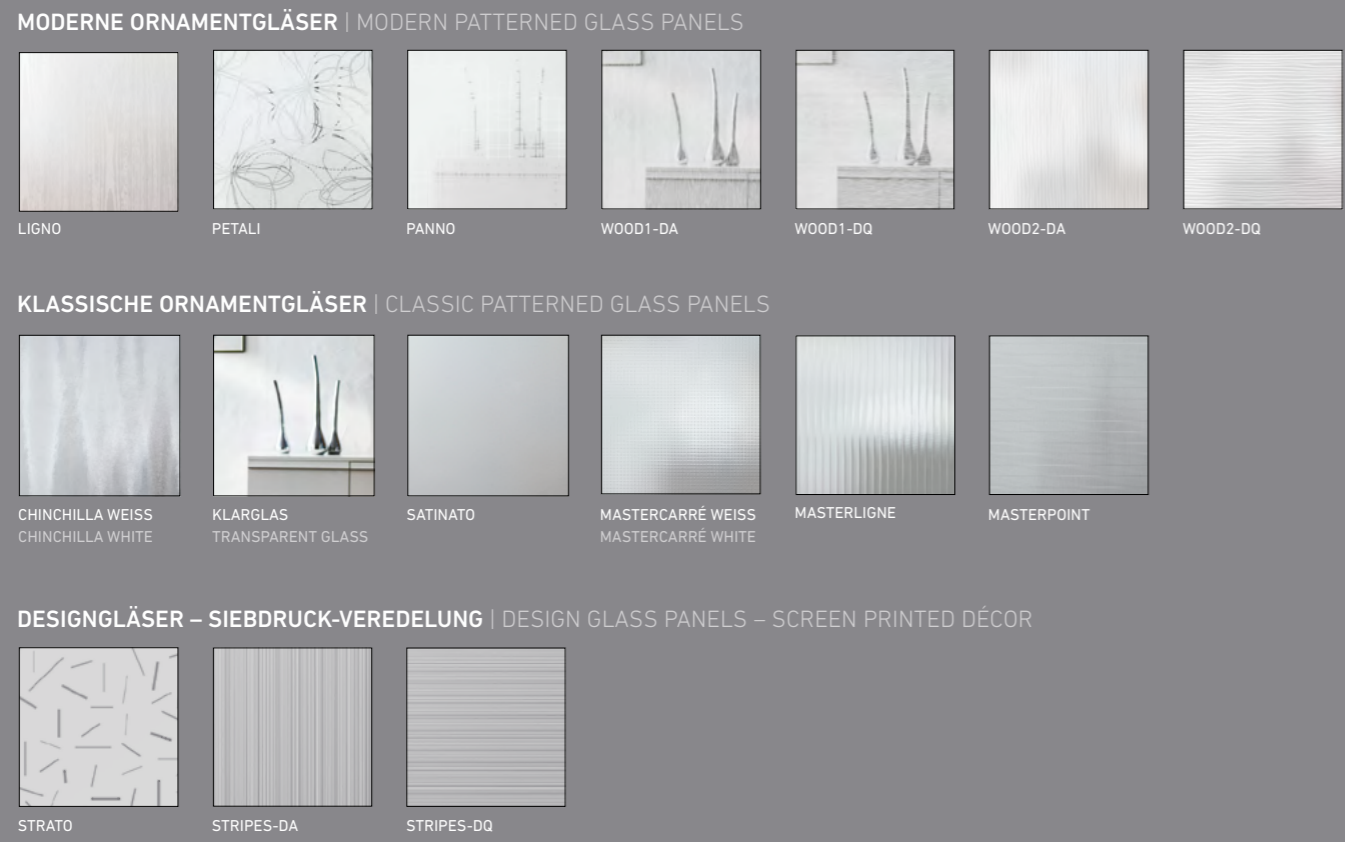
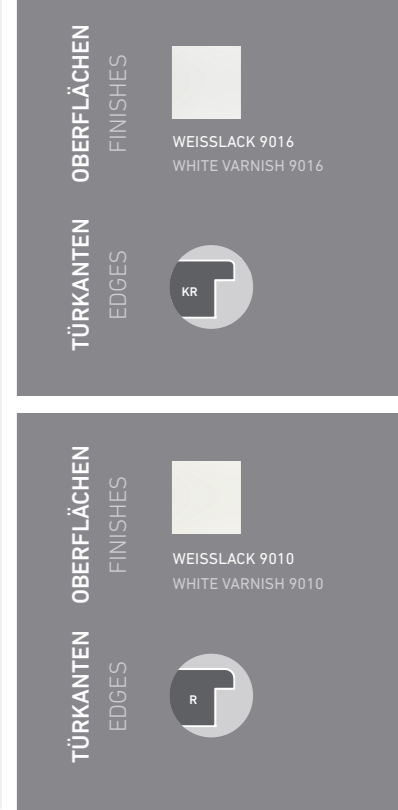
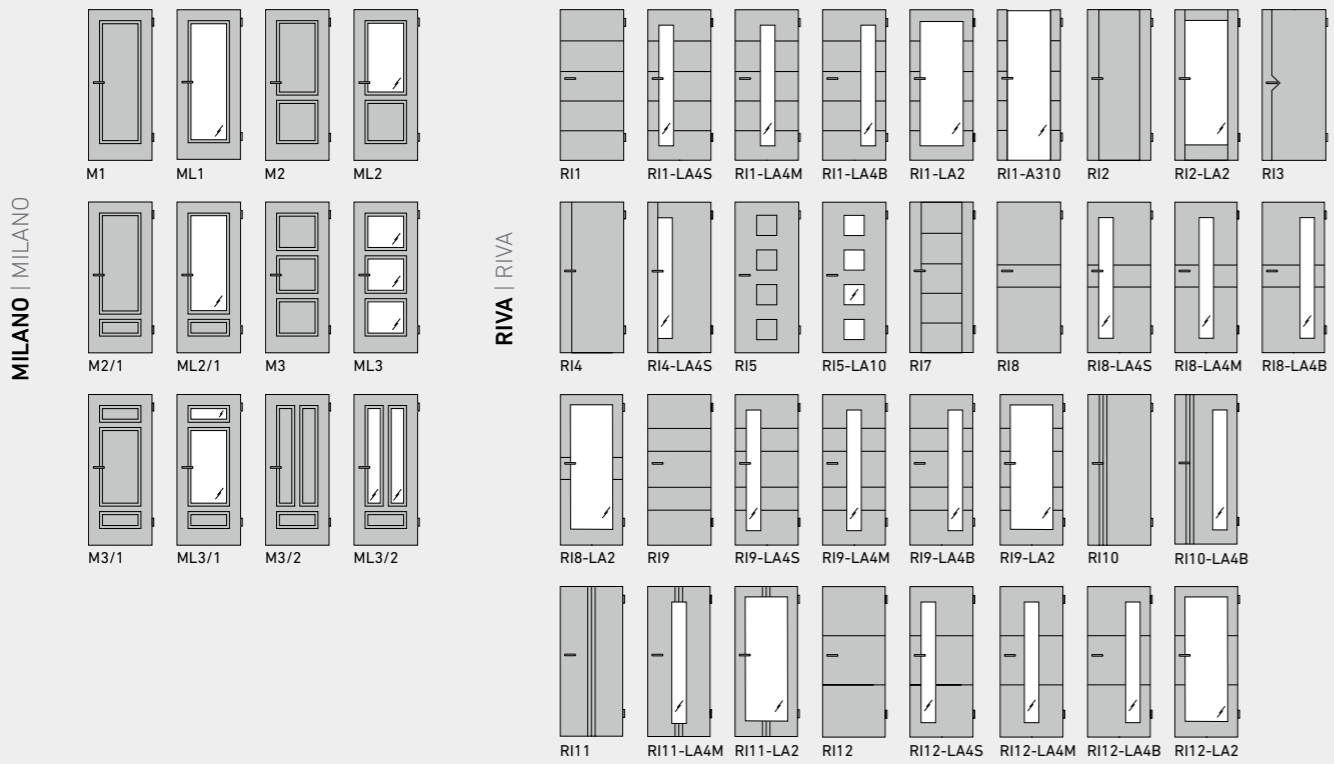

# Das STILTÜREN-Programm

The STYLISTIC DOOR range

## **KLASSISCH-MODERNE TÜREN, DIE RUHE AUSSTRAHLEN**

Unsere STILTÜREN in zeitloser Optik passen zu jedem Wohnstil.

## **CLASSIC, MODERN DOORS THAT EXUDE A SENSE OF CALM**

Our STYLE DOORS have timeless appeal that harmonises with any style of interior design.





**AMRUM**  
**Weißlack 9016**

AMRUM  
White varnish 9016

Offen für Harmonie und immer stilvoll:  
unsere klassischen Weißlacktüren.

Always harmonious, always elegant:  
our classic white varnish doors.





AMRUM  
Weißlack 9016

## Stilvolle Einblicke Stylish perspectives

Ein hochwertiges Erscheinungsbild und Glasdetails nach Wahl werten jeden Raum auf.  
A elegant look combined with optional glass details enhances any room.

### QUERSCHNITT | CROSS

KLEINE RUNDKANTE | SMALL ROUNDED EDGE



BESCHLAG  
NOVO

GRAPHITSCHWARZ  
GRAPHITE BLACK



BB/PZ/WC



smart2lock

EDELSTAHL MATT  
STAINLESS STEEL MATT



BB/PZ/WC



smart2lock



<b>MODELL</b>	1 AMRUM AS2
<b>OBERFLÄCHE</b>	Weißlack 9016
<b>GLAS</b>	-
<b>ZARGE</b>	KR1
<b>BESCHLAG</b>	NOVO, Graphitschwarz
<b>MODEL</b>	AMRUM AS2
<b>FINISH</b>	White varnish 9016
<b>GLASS</b>	-
<b>FRAME</b>	KR1
<b>FITTINGS</b>	MONO, Graphite black

<b>MODELL</b>	2 AMRUM ASL2
<b>OBERFLÄCHE</b>	Weißlack 9016
<b>GLAS</b>	SATINATO, Standard-Ornamentglas
<b>ZARGE</b>	KR1
<b>BESCHLAG</b>	NOVO, Graphitschwarz
<b>MODEL</b>	AMRUM ASL2
<b>FINISH</b>	White varnish 9016
<b>GLASS</b>	SATINATO, standard patterned glass
<b>FRAME</b>	KR1
<b>FITTINGS</b>	MONO, Graphite black

<b>MODELL</b>	3 AMRUM AM1
<b>OBERFLÄCHE</b>	Weißlack 9016
<b>GLAS</b>	-
<b>ZARGE</b>	KR1
<b>BESCHLAG</b>	NOVO, Graphitschwarz
<b>MODEL</b>	AMRUM AM1
<b>FINISH</b>	White varnish 9016
<b>GLASS</b>	-
<b>FRAME</b>	KR1
<b>FITTINGS</b>	MONO, Graphite black

<b>MODELL</b>	4 AMRUM AML1
<b>OBERFLÄCHE</b>	Weißlack 9016
<b>GLAS</b>	SATINATO, Standard-Ornamentglas
<b>ZARGE</b>	KR1
<b>BESCHLAG</b>	NOVO, Graphitschwarz
<b>MODEL</b>	AMRUM AML1
<b>FINISH</b>	White varnish 9016
<b>GLASS</b>	SATINATO, standard patterned glass
<b>FRAME</b>	KR1
<b>FITTINGS</b>	MONO, Graphite black

<b>MODELL</b>	5 AMRUM AML1/3
<b>OBERFLÄCHE</b>	Weißlack 9016
<b>GLAS</b>	SATINATO, Standard-Ornamentglas
<b>ZARGE</b>	KR1
<b>BESCHLAG</b>	NOVO, Edelstahl Matt
<b>MODEL</b>	AMRUM AML1/3
<b>FINISH</b>	White varnish 9016
<b>GLASS</b>	SATINATO, standard patterned glass
<b>FRAME</b>	KR1
<b>FITTINGS</b>	NOVO, Stainless steel matt

<b>MODELL</b>	6 AMRUM AM5
<b>OBERFLÄCHE</b>	Weißlack 9016
<b>GLAS</b>	-
<b>ZARGE</b>	KR1
<b>BESCHLAG</b>	NOVO, Edelstahl Matt
<b>MODEL</b>	AMRUM AM5
<b>FINISH</b>	White varnish 9016
<b>GLASS</b>	-
<b>FRAME</b>	KR1
<b>FITTINGS</b>	NOVO, Stainless steel matt

<b>MODELL</b>	7 AMRUM AML5
<b>OBERFLÄCHE</b>	Weißlack 9016
<b>GLAS</b>	WOOD1-DQ, Design-Ornamentglas
<b>ZARGE</b>	KR1
<b>BESCHLAG</b>	NOVO, Edelstahl Matt
<b>MODEL</b>	AMRUM AML5
<b>FINISH</b>	White varnish 9016
<b>GLASS</b>	WOOD1-DQ, design patterned glass
<b>FRAME</b>	KR1
<b>FITTINGS</b>	NOVO, Stainless steel matt



**JETZT TESTEN**  
Im Online-Türentool „DieTÜR“ von GARANT kombinieren Sie mit einfachen Klicks Ihre individuelle Wunschtür.  
**TEST NOW**  
Use GARANT's online door tool 'DieTÜR' to create your own custom door in just a few clicks.



AMRUM  
Weißlack 9010

## Stilbewusstsein beweisen Superior elegance

Mit unseren Weißlacktüren in zeitlos-moderner Kassettenoptik.  
With our white varnish doors in a timeless, modern panelled look.

### QUERSCHNITT | CROSS

RUNDKANTE | ROUNDED EDGE

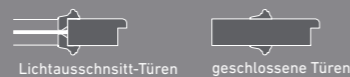

Lichtausschnitt-Türen

geschlossene Türen



BESCHLAG  
MONO

GRAPHITSCHWARZ  
GRAPHITE BLACK



BB/PZ/WC



smart2lock

EDELSTAHL MATT  
STAINLESS STEEL MATT



BB/PZ/WC



smart2lock



<b>MODELL</b>	1 AMRUM AS2
<b>OBERFLÄCHE</b>	Weißlack 9010
<b>GLAS</b>	-
<b>ZARGE</b>	R1
<b>BESCHLAG</b>	MONO, Graphitschwarz
<b>MODEL</b>	AMRUM AS2
<b>FINISH</b>	White varnish 9010
<b>GLASS</b>	-
<b>FRAME</b>	R1
<b>FITTINGS</b>	MONO, Graphite black

<b>MODELL</b>	2 AMRUM ASL2
<b>OBERFLÄCHE</b>	Weißlack 9010
<b>GLAS</b>	SATINATO, Standard-Ornamentglas
<b>ZARGE</b>	R1
<b>BESCHLAG</b>	MONO, Graphitschwarz
<b>MODEL</b>	AMRUM ASL2
<b>FINISH</b>	White varnish 9010
<b>GLASS</b>	SATINATO, standard patterned glass
<b>FRAME</b>	R1
<b>FITTINGS</b>	MONO, Graphite black

<b>MODELL</b>	3 AMRUM AM1
<b>OBERFLÄCHE</b>	Weißlack 9010
<b>GLAS</b>	-
<b>ZARGE</b>	R1
<b>BESCHLAG</b>	MONO, Graphitschwarz
<b>MODEL</b>	AMRUM AM1
<b>FINISH</b>	White varnish 9010
<b>GLASS</b>	-
<b>FRAME</b>	R1
<b>FITTINGS</b>	MONO, Graphite black

<b>MODELL</b>	4 AMRUM AML1
<b>OBERFLÄCHE</b>	Weißlack 9010
<b>GLAS</b>	SATINATO, Standard-Ornamentglas
<b>ZARGE</b>	R1
<b>BESCHLAG</b>	MONO, Graphitschwarz
<b>MODEL</b>	AMRUM AML1
<b>FINISH</b>	White varnish 9010
<b>GLASS</b>	SATINATO, standard patterned glass
<b>FRAME</b>	R1
<b>FITTINGS</b>	MONO, Graphite black

<b>MODELL</b>	5 AMRUM AML1/3
<b>OBERFLÄCHE</b>	Weißlack 9010
<b>GLAS</b>	SATINATO, Standard-Ornamentglas
<b>ZARGE</b>	R1
<b>BESCHLAG</b>	MONO, Edelstahl Matt
<b>MODEL</b>	AMRUM AML1/3
<b>FINISH</b>	White varnish 9010
<b>GLASS</b>	SATINATO, standard patterned glass
<b>FRAME</b>	R1
<b>FITTINGS</b>	MONO, Stainless steel matt

<b>MODELL</b>	6 AMRUM AM5
<b>OBERFLÄCHE</b>	Weißlack 9010
<b>GLAS</b>	-
<b>ZARGE</b>	R1
<b>BESCHLAG</b>	MONO, Edelstahl Matt
<b>MODEL</b>	AMRUM AM5
<b>FINISH</b>	White varnish 9010
<b>GLASS</b>	-
<b>FRAME</b>	R1
<b>FITTINGS</b>	MONO, Stainless steel matt

<b>MODELL</b>	7 AMRUM AML5
<b>OBERFLÄCHE</b>	Weißlack 9010
<b>GLAS</b>	PETALI, Design-Ornamentglas
<b>ZARGE</b>	R1
<b>BESCHLAG</b>	MONO, Edelstahl Matt
<b>MODEL</b>	AMRUM AML5
<b>FINISH</b>	White varnish 9010
<b>GLASS</b>	PETALI, design patterned glass
<b>FRAME</b>	R1
<b>FITTINGS</b>	MONO, Stainless steel matt



**JETZT TESTEN**  
Im Online-Türentool „DieTÜR“ von GARANT kombinieren Sie mit einfachen Klicks Ihre individuelle Wunschtür.  
**TEST NOW**  
Use GARANT's online door tool "DieTÜR" to create your own custom door in just a few clicks.

# Gesamtübersicht STILTÜREN-Programm

## Overview of the STYLISTIC DOOR range

AMRUM | AMRUM

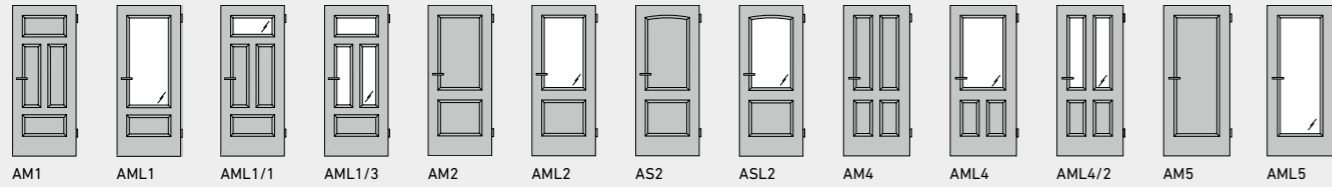

OBERFLÄCHEN  
FINISHES

WEISSLACK 9016  
WHITE VARNISH 9016

OBERFLÄCHEN  
FINISHES

WEISSLACK 9010  
WHITE VARNISH 9010

TÜRKANTEN  
EDGES



TÜRKANTEN  
EDGES



### MODERNE ORNAMENTGLÄSER | MODERN PATTERNED GLASS PANELS

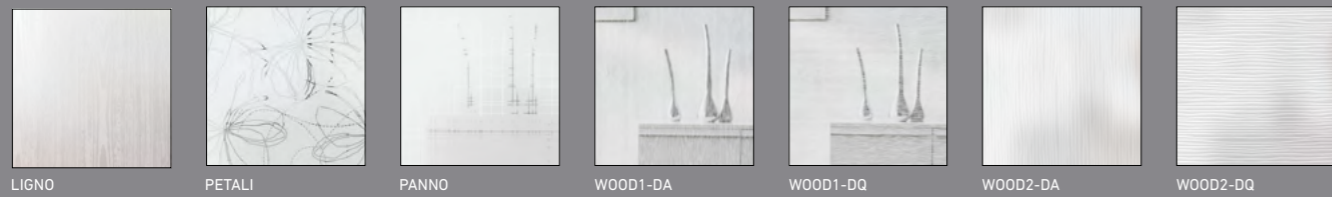

### DESIGNGLÄSER – SIEBDRUCK-VEREDELUNG | DESIGN GLASS PANELS – SCREEN PRINTED DÉCOR

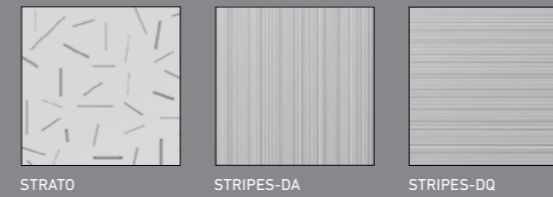

GLÄSER | GLASS PANELS

### KLASSISCHE ORNAMENTGLÄSER | CLASSIC PATTERNED GLASS PANELS



TOP-BESCHLÄGE | TOP-FERRURE

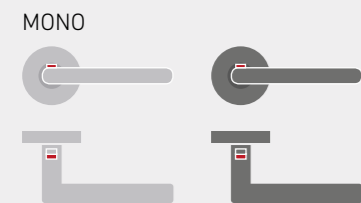

WÄHLBAR IN EDELSTAHL MATT ODER GRAPHITSCHWARZ  
AVAILABLE IN STAINLESS STEEL MATT OR GRAPHITE BLACK

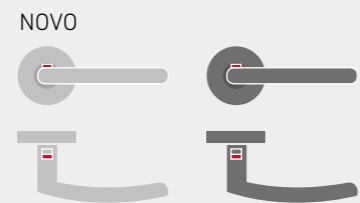

WÄHLBAR IN EDELSTAHL MATT ODER GRAPHITSCHWARZ  
AVAILABLE IN STAINLESS STEEL MATT OR GRAPHITE BLACK

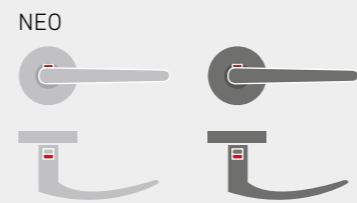

WÄHLBAR IN EDELSTAHL MATT ODER GRAPHITSCHWARZ  
AVAILABLE IN STAINLESS STEEL MATT OR GRAPHITE BLACK

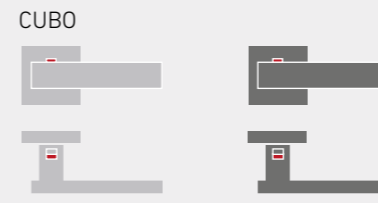

WÄHLBAR IN EDELSTAHL MATT ODER GRAPHITSCHWARZ  
AVAILABLE IN STAINLESS STEEL MATT OR GRAPHITE BLACK

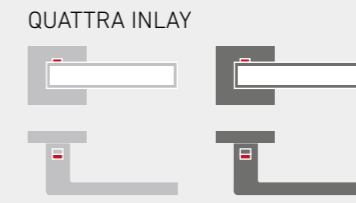

WÄHLBAR IN EDELSTAHOPTIK MATT ODER GRAPHITSCHWARZ  
AVAILABLE IN MATT STAINLESS STEEL LOOK OR GRAPHITE BLACK

INLAYS | INLAYS





# Elemente

## Elements

Beim Thema Türen sind wir in unserem Element und können Ihnen mit Sicherheit immer die richtigen Türelemente bieten. Unsere durchdachten Lösungen ermöglichen Ihnen die Umsetzung Ihrer individuellen Raumkonzepte.

We're in our element when it comes to the subject of doors, and we guarantee we can always provide you with the perfect door elements. Our clever solutions enable you to realise your personal interior design concepts.



WINDFANGELEMENTE UND SCHIEBETÜRLÖSUNGEN



DOPPELTÜREN (2-FLG. TÜREN)



GESCHOSSHOHE ELEMENTE



## Geschosshohe Elemente Ceiling-height elements

Schön und praktisch | Beautiful and practical

### SCHÖN FÜR DIE OPTIK, PRAKTISCH FÜR ALLTÄGLICHE SITUATIONEN

Mit unseren geschosshohen Elementen sorgen Sie für eine großzügige Türen-Optik und nutzen Ihre Raumhöhe optimal aus.

### BEAUTIFUL TO LOOK AT; PRACTICAL IN EVERYDAY USE.

Our ceiling-height elements give the door a generously-dimensioned appearance and make optimum use of the room height.

VIDEO Geschosshohe Elemente | Ceiling-height elements

[KLICK](#)

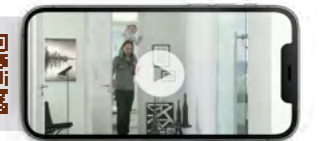

Beschlag mit PZ-Schloss



Ganzglastür mit Ganzglas-Oberlicht



Magnet-Schließblech



Stumpfes Türelement mit Oberblende



Stumpfes Türelement mit Oberlicht



## Windfangelemente und Schiebetürlösungen Draught-stop elements and sliding doors



### **SCHIEBETÜRBESCHLAG LINE**

Das schlanke Schiebetürsystem im Edelstahl-Design für Holz- und Ganzglastüren. LINE ist wahlweise auch mit Einzugsdämpfung (beidseitig) lieferbar.

### **LINE SLIDING DOOR FITTING**

The streamlined sliding door system in a stainless steel design for wood and all-glass doors is also available with an optional soft close function (both sides).



### **SCHIEBETÜRBESCHLAG BASIC – AUSFÜHRUNG „VOR DER WAND LAUFEND“**

Die gehobene Holzklasse, unser BASIC-Schiebetürbeschlag für Holz- und Ganzglastüren. Öffnen Sie Türen auf die klassische Art. BASIC ist wahlweise auch mit Einzugsdämpfung (ein- oder beidseitig) lieferbar.

### **BASIC SLIDING DOOR FITTING – ‘FRONT OF WALL’ VERSION**

Our BASIC sliding door fittings for wood and all-glass doors are premium hardware. Open the doors in the conventional way. BASIC is also available with an optional soft close function (one or both sides).

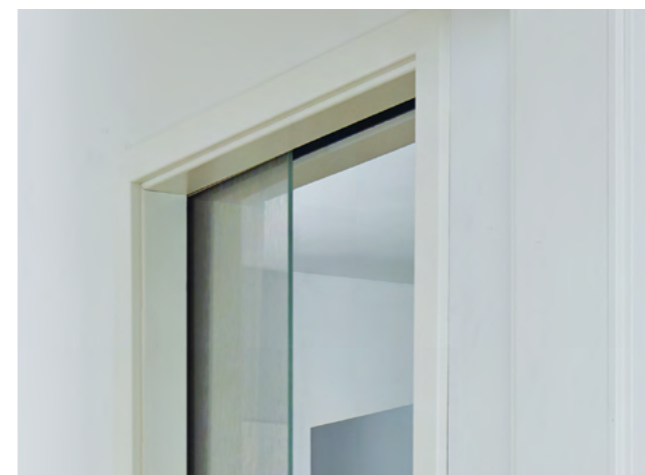

### **SCHIEBETÜRBESCHLAG BASIC – AUSFÜHRUNG „IN DER WAND LAUFEND“**

Innenlaufende Schiebetüren mit dem BASIC-Schiebetürbeschlag – egal ob als Holz- oder Ganzglastüren – sind die ideale Lösung, wenn es für normale Drehtüren in den verbundenen Räumen keinen Öffnungs- und Bewegungsraum gibt.

### **BASIC SLIDING DOOR FITTINGS – ‘IN-WALL’ VERSION**

In-wall sliding doors – both wood and glass models – with BASIC sliding door fittings are the ideal solution when there is no space for conventionally opening doors in connected rooms.



Windfangelemente und Schiebetürlösungen

# Schiebetürbeschlag LINE

## LINE sliding door fittings

Platzsparendes Design auch für kleine Räume.  
Space-saving design for small rooms.



### SCHIEBETÜRBESCHLAG LINE

Das schlanke Schiebetürsystem im Edelstahl-Design für Holz- und Ganzglastüren. LINE ist wahlweise auch mit Einzugsdämpfung (beidseitig) lieferbar.

### LINE SLIDING DOOR FITTINGS

The streamlined sliding door system in a stainless steel design for wood and all-glass doors is also available with an optional soft close function (both sides).



LINE mit Anschlagkasten



Befestigung einer Holztür im Schiebetürbeschlag LINE

# LINE-Schiebetürbeschlag mit Inlay

## LINE sliding door fitting with inlay

VIDEO Windfangelemente und Schiebetürlösungen  
Draught-stop elements and sliding doors

[KLICK](#)



In diesen Oberflächen erhältlich | Available in these finishes



WEISS 9016  
WHITE 9016



WEISS 9010  
WHITE 9010



SCHWARZ 9005  
BLACK 9005



Befestigung einer Ganzglastür im Schiebetürbeschlag LINE



LINE ohne Anschlagkasten

## Schiebetürbeschlag BASIC – vor der Wand laufend BASIC sliding door fitting – ‘front of wall’ version



BASIC mit Anschlagkasten

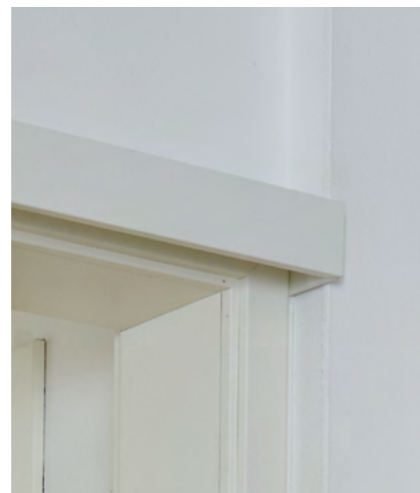

BASIC ohne Anschlagkasten

Die klassische Variante für Schiebetüren: Der obere Laufkasten – farb- und dekor- gleich zur verwendeten Zarge – versteckt gekonnt den Schiebemechanismus. Mit dem vorderen Anschlagkasten wird der optionale Einsatz eines Schlosses möglich.

The classic version for sliding doors: The top casing is identical in colour and décor to the door frame to cleverly hide the sliding mechanism. A lock can be optionally used in conjunction with the front rabbet.



## Schiebetürbeschlag BASIC – in der Wand laufend BASIC sliding door fitting – ‘in-wall’ version

### **SCHIEBETÜRBESCHLAG BASIC – AUSFÜHRUNG „IN DER WAND LAUFEND“ FÜR GANZGLASTÜREN**

Innenlaufende Schiebetürelemente mit dem BASIC-Schiebetürbeschlag für Ganzglastüren sind die ideale Lösung, wenn es für herkömmliche Ganzglastüren als Drehtüren in den verbundenen Räumen keinen Öffnungs- und Bewegungsraum gibt.

### **BASIC SLIDING DOOR FITTING – ‘IN WALL’ VERSION FOR ALL-GLASS DOORS**

In-wall sliding door elements with the BASIC sliding door fittings for all-glass doors are the ideal solution when there is no space for conventionally opening doors in connected rooms.

### **SCHIEBETÜRBESCHLAG BASIC – AUSFÜHRUNG „IN DER WAND LAUFEND“ FÜR HOLZTÜREN**

Innenlaufende Schiebetürelemente mit dem BASIC-Schiebetürbeschlag für Holztüren sind die ideale Lösung, wenn es keinen Platz für herkömmliche Drehtürsysteme gibt.

### **BASIC SLIDING DOOR FITTINGS – ‘IN-WALL’ VERSION FOR WOODEN DOORS**

In-wall sliding door elements with the BASIC fittings for wooden doors are the ideal solution when there is no deal solution when there is no space for conventionally opening doors.





**VERDOPPELN SIE IHRE MÖGLICHKEITEN**

Mit unseren 2-flügeligen Türen sorgen Sie für mehr Großzügigkeit, Offenheit und Licht. So kommen Ihre Räume ganz groß heraus.

**DOUBLE YOUR POSSIBILITIES**

With our double-leaf doors you get more space, openness and light. They help you to maximise your room space.



MILANO ML1, 2-flügelig, Verglasung PANNO



NT-DA, 2-flügelig



GANZGLAS-Tür 2-flügelig in Windfang-Zarge, Seitenteilverglasung KLARGLAS, Verglasung Tür Design RI1.1, Weißlack 9010



**Doppeltüren (2-flg.) | Double-leaf doors**

Großzügigkeit mal 2 | Twice the size

# Technische Details

## Technical details

### ENTDECKEN SIE UNSERE TÜRENDETAILS AUF EINEN BLICK

Eine Übersicht über Glasprogramm, Beschläge, Zargen und spezielle Funktionen.

### ALL THE DETAILS ABOUT OUR DOORS AT A GLANCE

An overview of the glass range, fittings, frames and special functions.

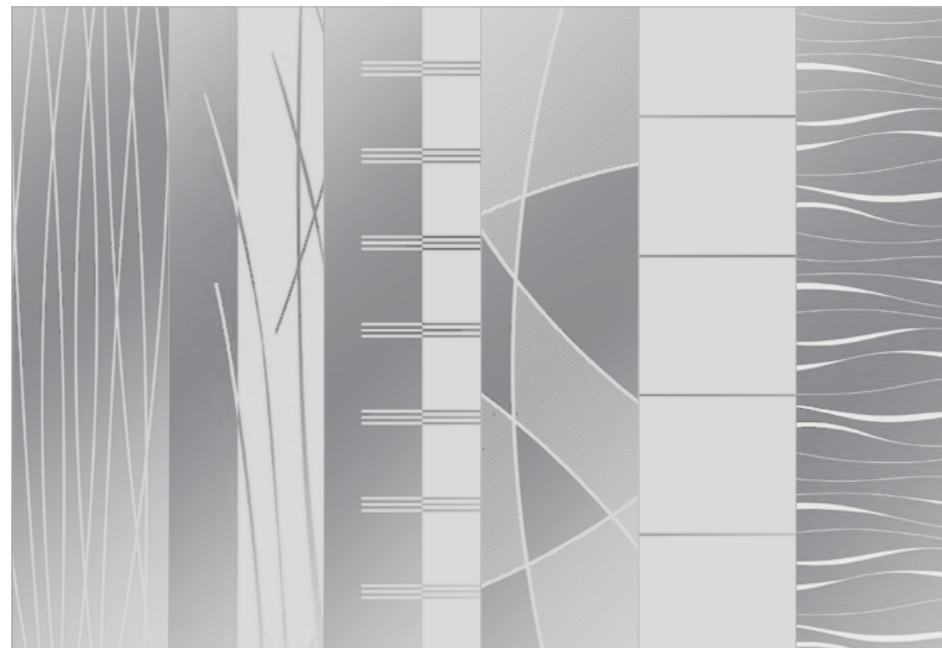

**GARANT-DESIGNVERBUND**  
Ornamentgläser als Ganzglastür  
und Lichtausschnittgläser erhältlich.

**GARANT DESIGN COMPOSITION**  
Patterned glass is available for  
doors and door panels.

# Ornamentglas für Ganzglastüren

## Patterned glass for all-glass doors

Moderne Ganzglastüren für raffinierte Lichtblicke.

Modern all-glass doors are a clever way to make rooms lighter.

### DESIGN-ORNAMENTGLAS | DESIGN PATTERNED GLASS

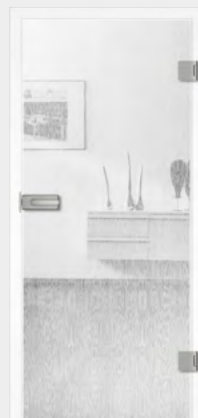

WOOD1-DA



WOOD1-DQ



WOOD2-DA



WOOD2-DQ



LIGNO



PETALI



PANNO

### STANDARD-ORNAMENTGLAS | STANDARD PATTERNED GLASS



CHINCHILLA WEISS  
CHINCHILLA WHITE



MASTERLIGNÈ



MASTERPOINT



MASTERCARRÉ



KLARGLAS  
TRANSPARENT GLASS



SATINATO



**GARANT-DESIGNVERBUND**  
Ornamentgläser als Ganzglastür  
und Lichtausschnittgläser erhältlich.

**GARANT DESIGN COMPOSITION**  
Patterned glass is available for  
doors and door panels.

# Ornamentglas für Lichtausschnitt-Türen

## Patterned glass for doors with panels

Wählen Sie Transparenz.  
Choose transparency.

### DESIGN-ORNAMENTGLAS | DESIGN PATTERNED GLASS



WOOD1-DA

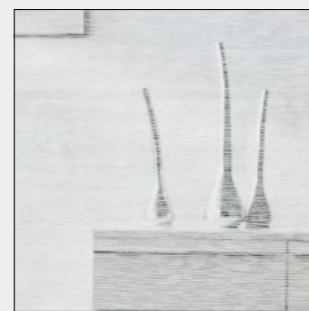

WOOD1-DQ

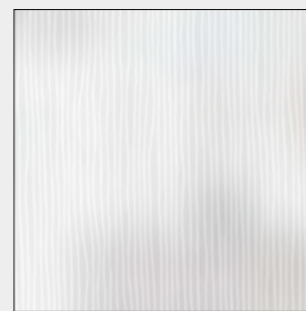

WOOD2-DA



WOOD2-DQ

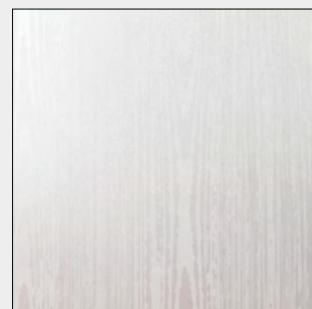

LIGNO

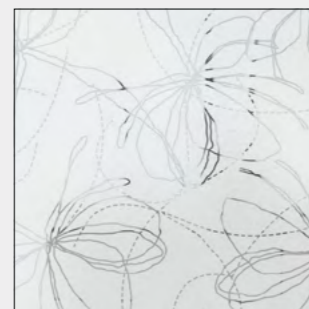

PETALI

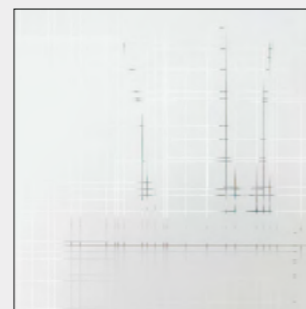

PANNO

### STANDARD-ORNAMENTGLAS | STANDARD PATTERNED GLASS

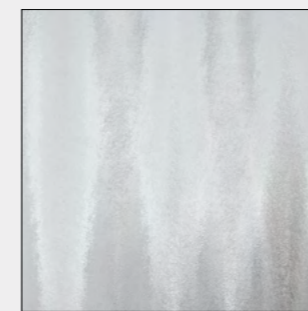

CHINCHILLA WEISS  
CHINCHILLA WHITE

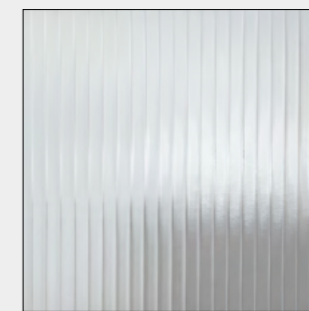

MASTERLIGNÈ

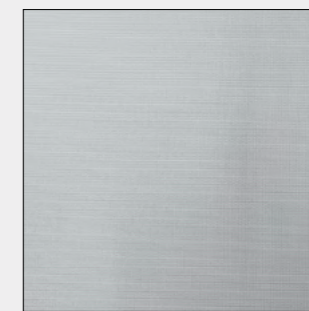

MASTERPOINT

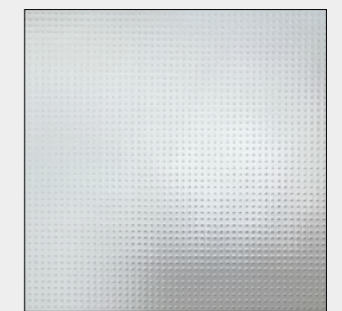

MASTERCARRÉ

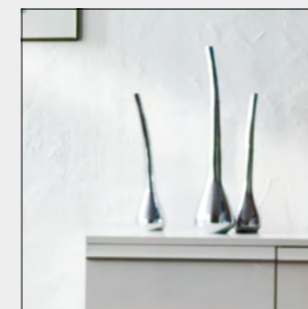

KLARGLAS  
TRANSPARENT GLASS

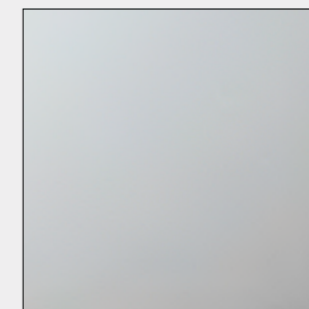

SATINATO

# Designglas für Ganzglastüren

## Design patterned glass for all-glass doors

Transparenz mit edlem Charakter.  
Elegant transparency.

**GARANT-DESIGNVERBUND**  
Designglas motive als Ganzglastür  
und Lichtausschnittgläser erhältlich.

**GARANT DESIGN COMPOSITION**  
Design glass motifs are available  
for all-glass doors and door panels.

### SIEBDRUCK-VEREDELUNG | SCREEN PRINTED DÉCOR



LINEUM



LINUS



SEVENTY



BAMBUS



FREE



LIPSO



DESIGN R11.1



DESIGN R11.2



DESIGN R14.1



DESIGN R18.1



DESIGN R110.1



ACCORDIA



DESIGN R111.1

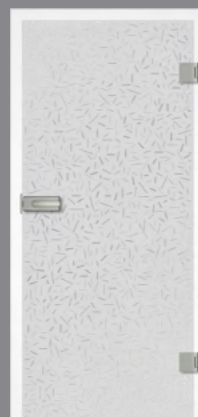

STRATO



STRIPES DA



STRIPES DQ

### LASER-VEREDELUNG | LASER DÉCOR



ARPA



PALLA



FIORE



SAGI

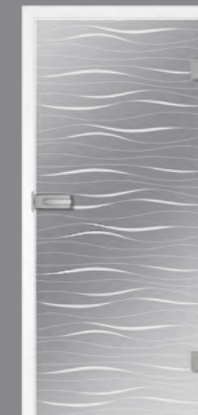

ONDA 1



ONDA 2



MOTUS



FLORA 1



FLORA 2



CENTRO



LINEA 1

# Designglas für Lichtausschnitt-Türen

## Design patterned glass for doors with panels

Weil ich einzigartigen Durchblick will.  
 Because I want unique vision.

### SIEBDRUCK-VEREDELUNG | SCREEN PRINTED DÉCOR



LINEUM



LINUS



SEVENTY



BAMBUS



FREE



LIPSO

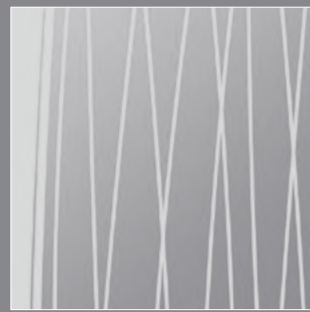

ACCORDIA



LINEA 1

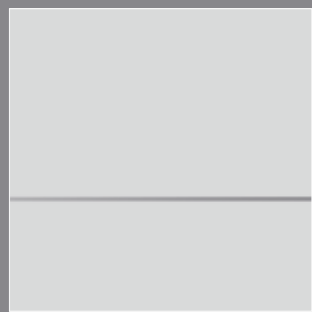

DESIGN RI1.1

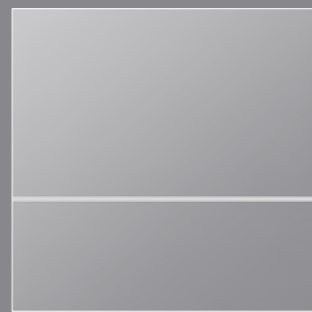

DESIGN RI1.2



STRATO



STRIPES DA/DQ

### LASER-VEREDELUNG | LASER DÉCOR



ARPA



PALLA



FIORE

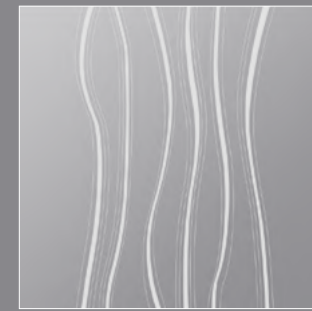

SAGI

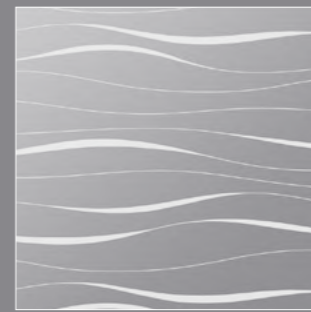

ONDA 1

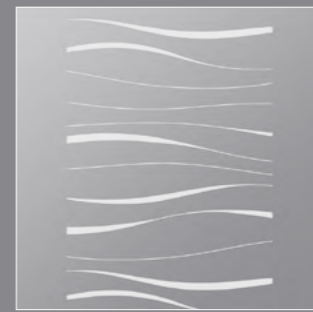

ONDA 2



MOTUS

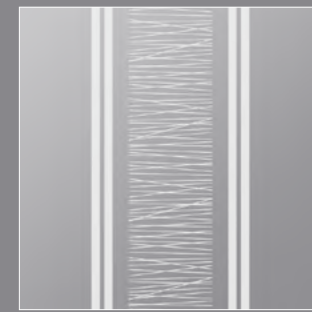

CENTRO



FLORA 1



FLORA 2

TOP

STYLE

PREMIUM

# Beschlagsvielfalt in Stil und System Diverse fitting styles and systems

## TÜRGRIFFE UND ZUBEHÖR FÜR ALLE ANWENDUNGEN

Türbeschläge sind ein prägendes Stilelement der Tür und unterstreichen die architektonische Note des Raums. Unser umfassendes Sortiment bietet eine Vielzahl an Designs und für jede Anforderung die passende Lösung: vom Türgriff, über das Glastürschloss bis hin zu passenden Bändern.

## DOOR HANDLES AND ACCESSORIES FOR ALL APPLICATIONS

Door handles are distinctive elements of the door. They make a style statement and underline the room's architectural tone. We offer a comprehensive range of designs and the perfect solutions for all requirements: from door handles to glass door locks and matching hinges.



TOP MONO



GARANT

Griffwerk

TOP

MONO

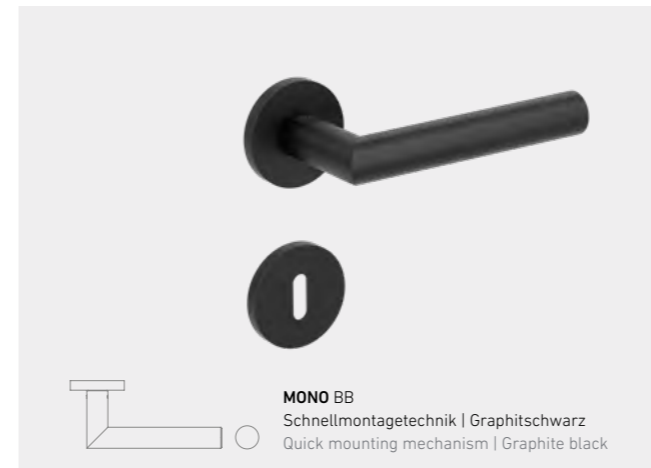

**MONO BB**  
Schnellmontagetechnik | Graphitschwarz  
Quick mounting mechanism | Graphite black

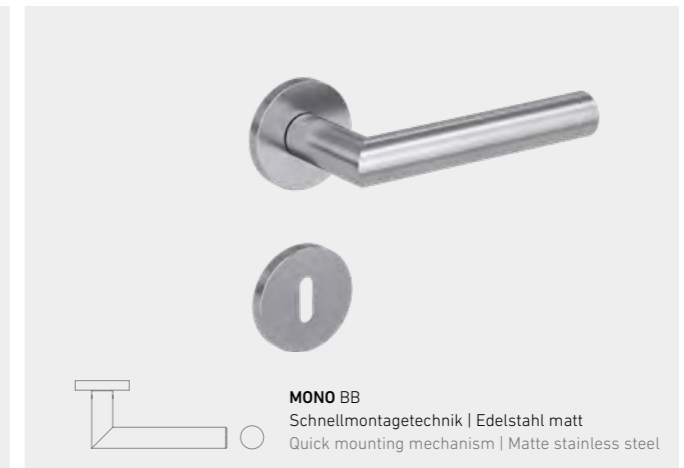

**MONO BB**  
Schnellmontagetechnik | Edelstahl matt  
Quick mounting mechanism | Matte stainless steel



**smart2lock**  
by GRIFFWERK  
**MONO**  
Schnellmontagetechnik | Graphitschwarz  
Quick mounting mechanism | Graphite black

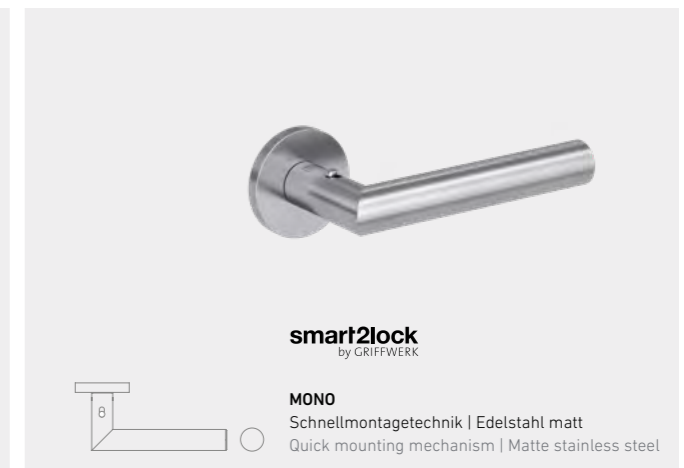

**smart2lock**  
by GRIFFWERK  
**MONO**  
Schnellmontagetechnik | Edelstahl matt  
Quick mounting mechanism | Matte stainless steel

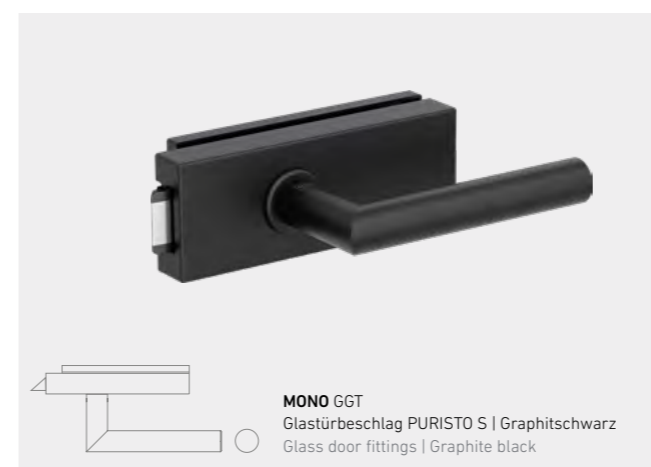

**MONO GGT**  
Glastürbeschlag PURISTO S | Graphitschwarz  
Glass door fittings | Graphite black



**MONO GGT**  
Glastürbeschlag PURISTO S | Edelstahl matt  
Glass door fittings | Matte stainless steel



**smart2lock**  
by GRIFFWERK  
**MONO GGT**  
Glastürbeschlag PURISTO S | Graphitschwarz  
Glass door fittings | Graphite black

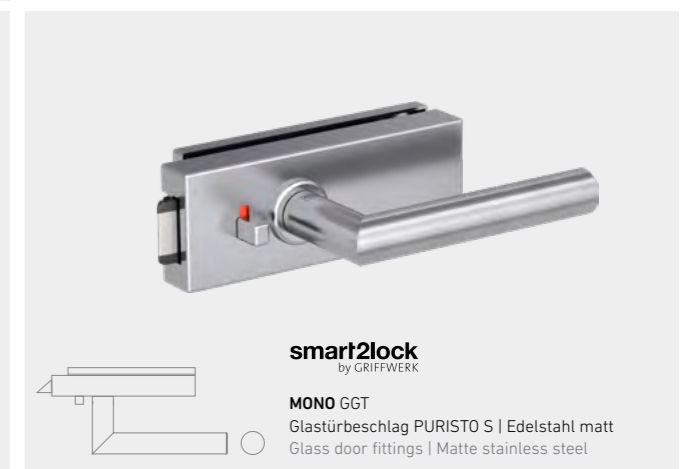

**smart2lock**  
by GRIFFWERK  
**MONO GGT**  
Glastürbeschlag PURISTO S | Edelstahl matt  
Glass door fittings | Matte stainless steel

TOP

NOVO

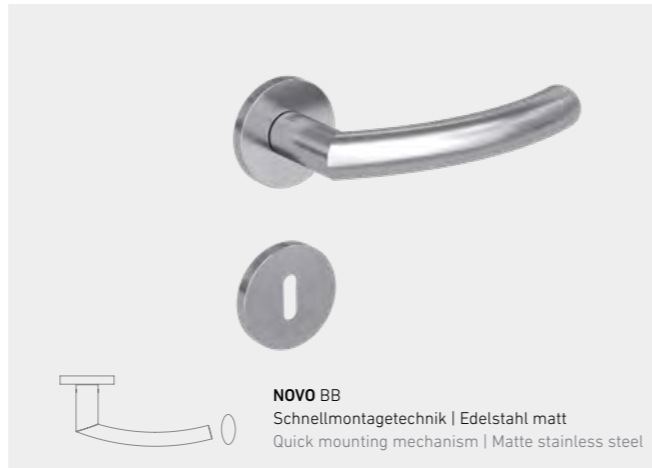
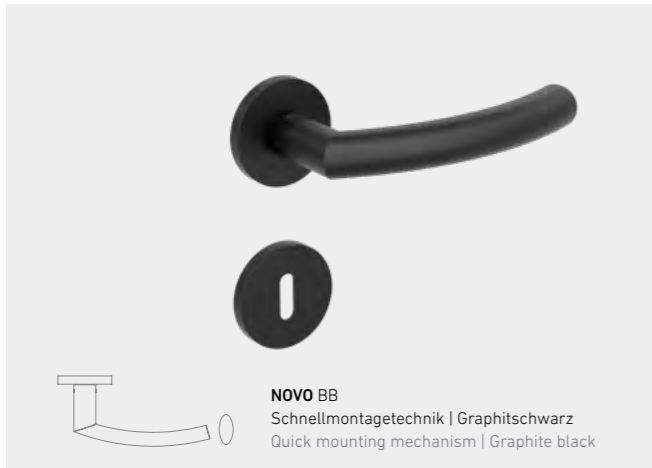

TOP

NEO



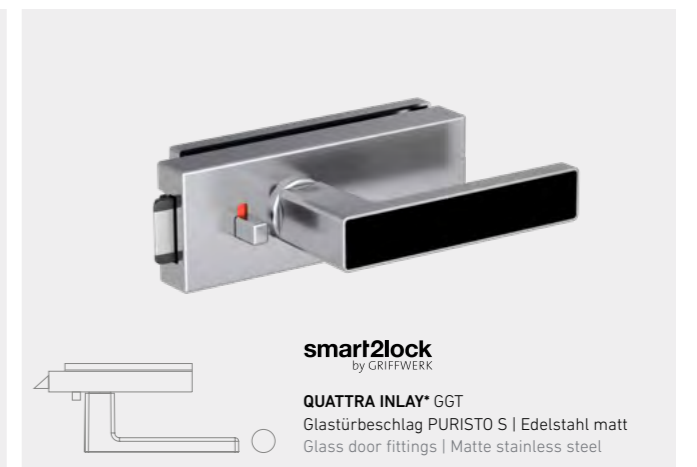
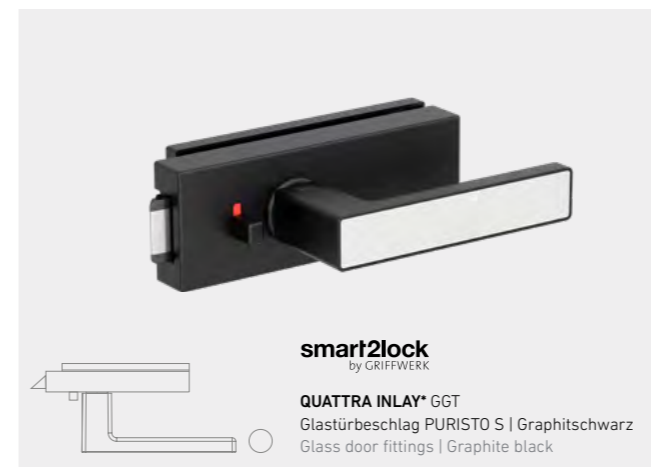
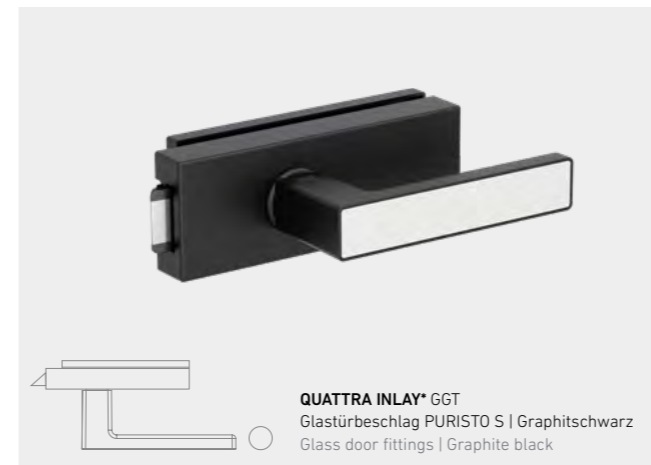
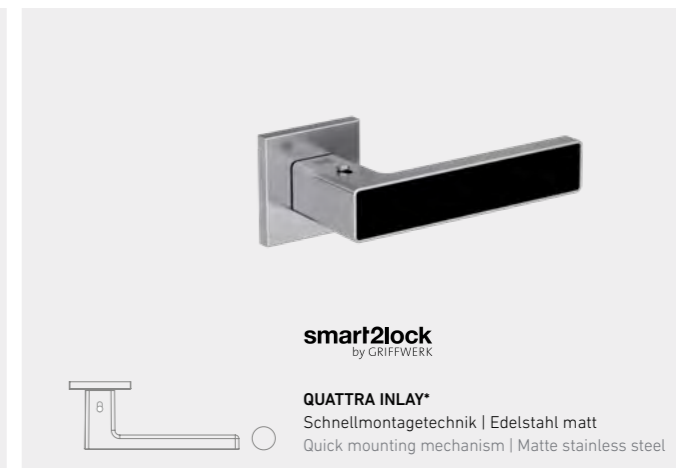
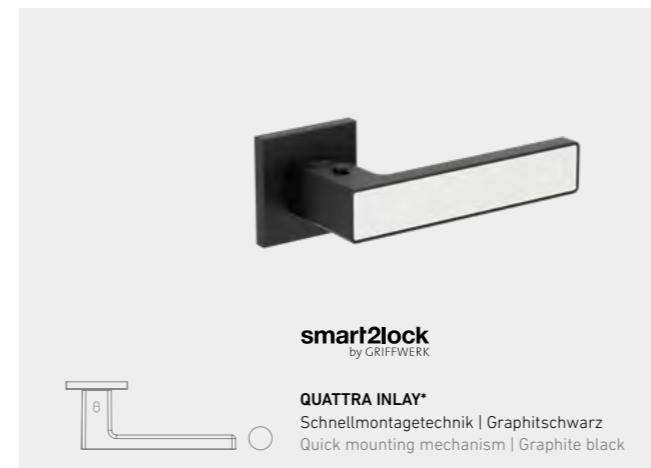
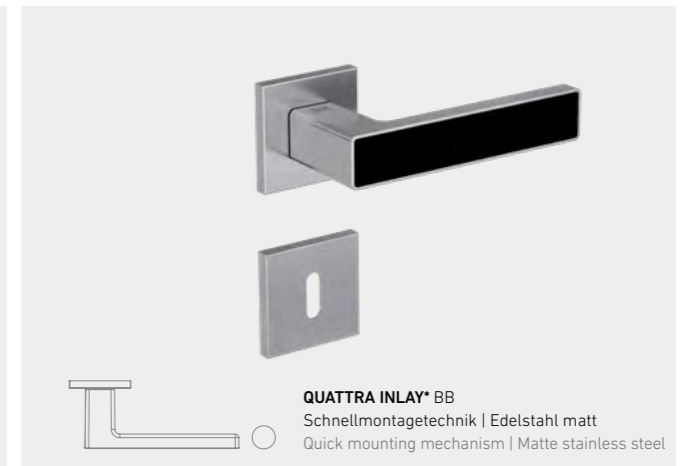
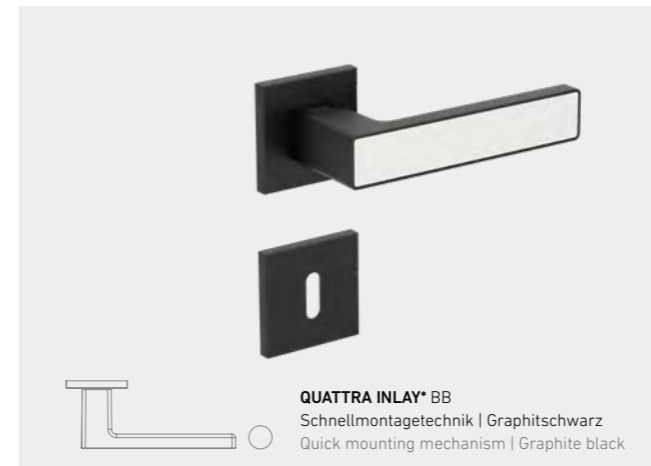
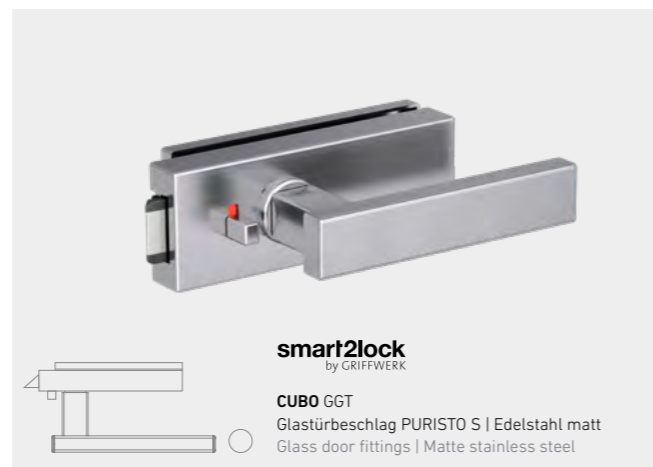
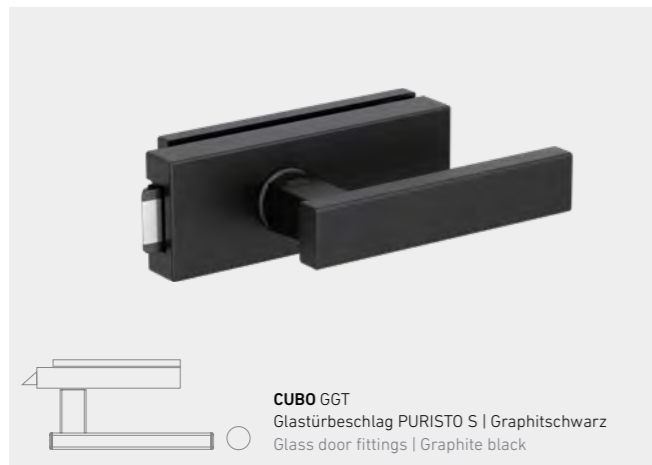
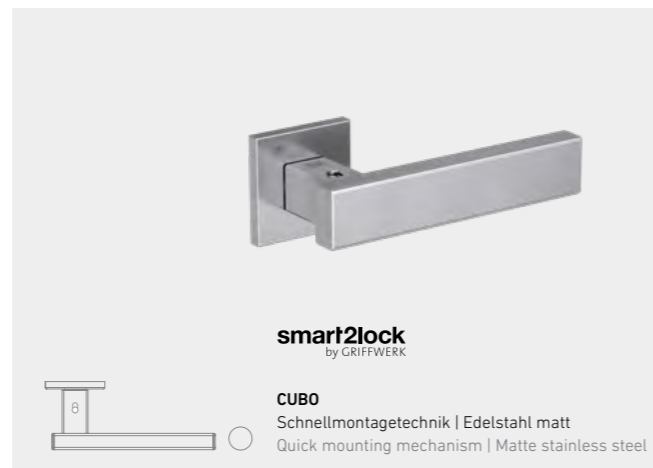
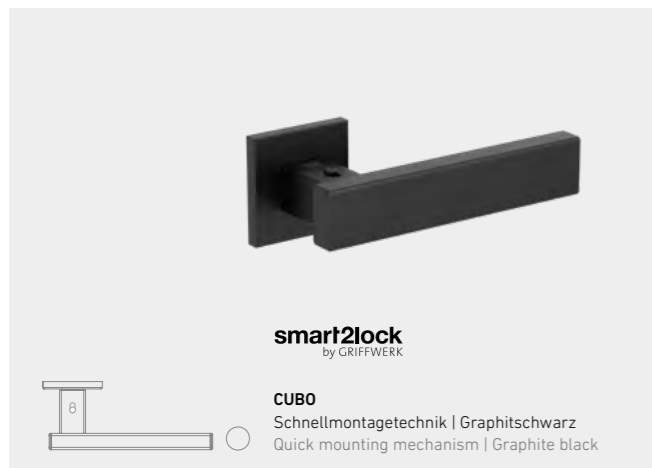
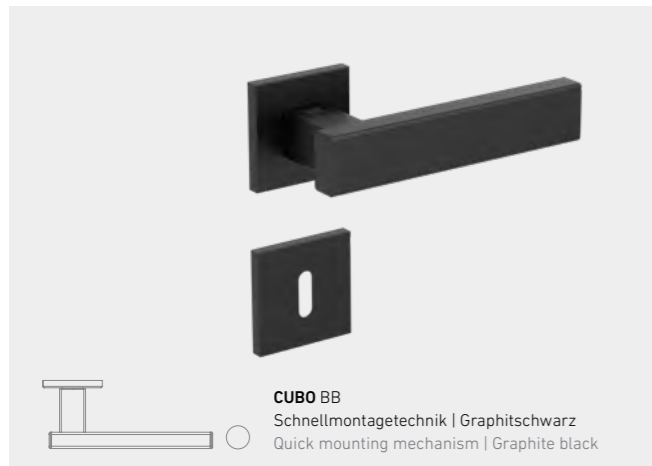

MONO

STANDARD-ROSETTE  
STANDARD ROSETTE



BB-Schloss Rosette  
BB lock with magnetic rosette

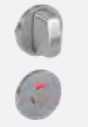

WC-Schloss  
WC lock



PZ-Schloss  
PZ lock



Schutzbeschlag EH, RD  
EH, RD security lock plate

BÄNDER SCHLÖSSER  
HINGES LOCKS



2-teiliges Holztürenband  
2-part wooden door hinge



3-teiliges Holztürenband  
3-part wooden door hinge



BB/PZ Schloss  
Schlossstulp  
BB/PC lock  
lock neck



Magnetschloß lang  
Schlossstulp  
Long magnetic lock  
lock neck



Schließblech lang  
Long locking plate

MONO

STANDARD  
STANDARD



UV-Schloss  
UV lock



PZ-Schloss  
PZ lock



smart2lock  
by GRIFFWERK

NOVO

STANDARD  
STANDARD



UV-Schloss  
UV lock



PZ-Schloss  
PZ lock



smart2lock  
by GRIFFWERK

NEO

STANDARD  
STANDARD



UV-Schloss  
UV lock



PZ-Schloss  
PZ lock



smart2lock  
by GRIFFWERK

CUBO

STANDARD  
STANDARD



UV-Schloss  
UV lock



PZ-Schloss  
PZ lock



smart2lock  
by GRIFFWERK

QUATTRA INLAY

STANDARD-ROSETTE  
STANDARD ROSETTE



BB-Schloss Rosette  
BB lock with magnetic rosette



WC-Schloss  
WC lock



PZ-Schloss  
PZ lock



Schutzbeschlag EH, RD  
EH, RD security lock plate

BÄNDER ZUBEHÖR  
HINGES ACCESSORIES



Gegenkasten (2-flg.)  
Strike box (2-part)



Band (3-tlg.)  
Hinge (3-part)



Schließblech kurz  
Short locking plate

MONO

STANDARD-ROSETTE  
STANDARD ROSETTE



BB-Schloss Rosette  
BB lock with magnetic rosette

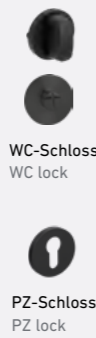

WC-Schloss  
WC lock

PZ-Schloss  
PZ lock



Schutzbeschlag EH, RD  
EH, RD security lock plate

PZW-Knopf  
PZW knob

BÄNDER SCHLÖSSER  
HINGES LOCKS



2-teiliges Holztürenband  
2-part wooden door hinge



3-teiliges Holztürenband  
3-part wooden door hinge



BB/PC Schloss  
Schloßstulp Schwarz  
BB/PC lock  
Graphite black lock neck



Magnetschloß lang  
Schloßstulp Schwarz  
Long magnetic lock  
Graphite black lock neck



Schließblech lang  
Long locking plate

MONO

STANDARD  
STANDARD



UV-Schloss  
UV lock



PZ-Schloss  
PZ lock



smart2lock  
by GRIFFWERK

NOVO

STANDARD  
STANDARD



UV-Schloss  
UV lock



PZ-Schloss  
PZ lock



smart2lock  
by GRIFFWERK

NEO

STANDARD  
STANDARD



UV-Schloss  
UV lock



PZ-Schloss  
PZ lock



smart2lock  
by GRIFFWERK

CUBO

STANDARD  
STANDARD



UV-Schloss  
UV lock



PZ-Schloss  
PZ lock



smart2lock  
by GRIFFWERK

QUATTRA INLAY

STANDARD-ROSETTE  
STANDARD ROSETTE



BB-Schloss Rosette  
BB lock with magnetic rosette



WC-Schloss  
WC lock

PZ-Schloss  
PZ lock

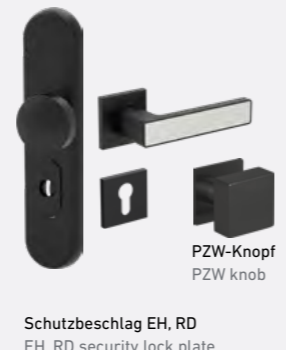

Schutzbeschlag EH, RD  
EH, RD security lock plate

PZW-Knopf  
PZW knob

BÄNDER ZUBEHÖR  
HINGES ACCESSORIES



Gegenkasten (2-flg.)  
Strike box (2-part)



Band (3-tlg.)  
Hinge (3-part)



Schließblech kurz  
Short locking plate



TOP

STYLE

PREMIUM

## Besondere Akzente setzen

Make a big statement

### DESIGNTÜRGRIFFE, DIE IN STIL UND HAPTİK ÜBERZEUGEN

Außergewöhnliches Design und mehr Komfort: Die Tür erfährt durch unsere Designtürgriffe eine zusätzliche Aufwertung. Zudem bieten die hochwertigen Oberflächen eine angenehme Haptik – ein Luxus, den sie täglich erleben können.

### DESIGNER DOOR HANDLES WITH IMPRESSIVE STYLE AND HAPTICS

Exceptional design and extra convenience: Our designer door handles make the door look even more exclusive. Their premium finishes also enhance the haptics for luxury you can experience every day.



AVUS PIATTA S



smart2lock  
by GRIFFWERK



**Griff  
werk**



**LUCIA PROFESSIONAL**  
Schraubtechnik | Graphitschwarz und Edelstahl matt  
Rund- oder Quadratrossette  
Screw mechanism | graphite black and matte stainless steel, round or square rosette

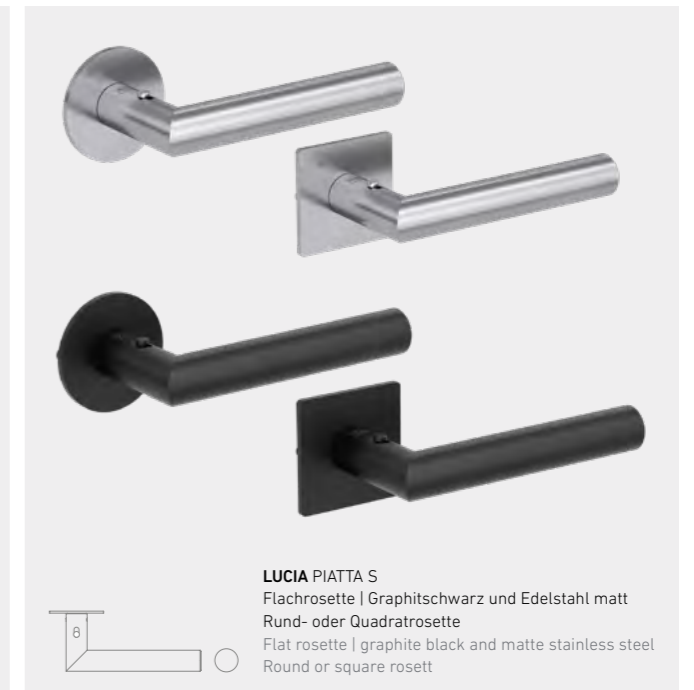

**LUCIA PIATTA S**  
Flachrossette | Graphitschwarz und Edelstahl matt  
Rund- oder Quadratrossette  
Flat rosette | graphite black and matte stainless steel, round or square rosette



**TRI 134**  
Schraubtechnik | Graphitschwarz und Edelstahl matt  
Rund- oder Quadratrossette  
Screw mechanism | graphite black and matte stainless steel, round or square rosette



**TRI 134 PIATTA S**  
Flachrossette | Graphitschwarz und Edelstahl matt  
Rundrossette  
Flat rosette | graphite black and matte stainless steel, round or square rosette

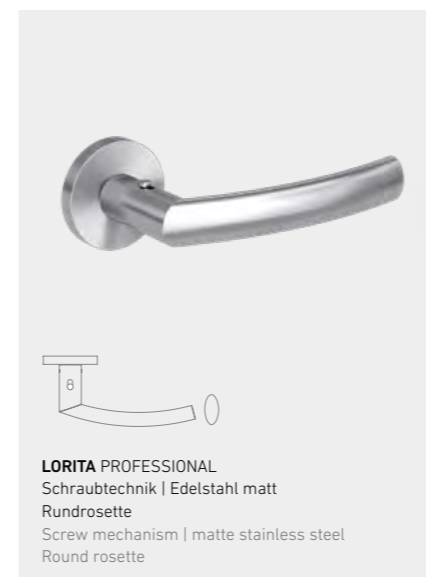

**LORITA PROFESSIONAL**  
Schraubtechnik | Edelstahl matt  
Rundrossette  
Screw mechanism | matte stainless steel  
Round rosette

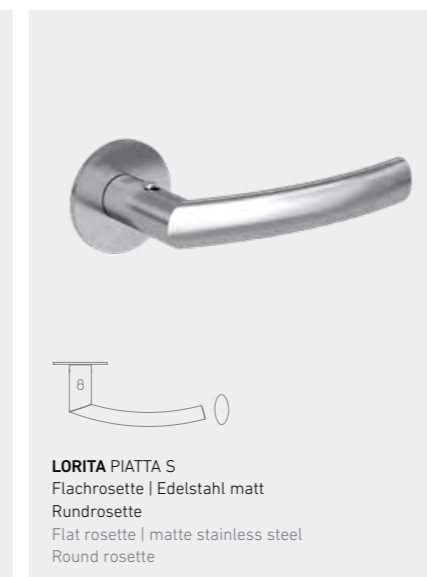

**LORITA PIATTA S**  
Flachrossette | Edelstahl matt  
Rundrossette  
Flat rosette | matte stainless steel  
Round rosette



**AVUS PIATTA S**  
Flachrossette | Graphitschwarz und Kaschmirgrau,  
Rundrossette  
Flat rosette | graphite black and cashmere grey,  
round rosette

## Türgriffe der Extraklasse

### Extra-special door handles

#### ONE – DESIGNKONZEPT OHNE ROSETTEN

Maximale Reduktion, dafür steht ONE: Auf Rosetten wird bei dieser Türgriffserie völlig verzichtet. Der Griff sitzt direkt auf dem Türblatt auf und passt dennoch auf Türen mit Standardschlössern. Bei der Version mit Schließmechanik wurde diese in den Griffhals integriert. Ein Griffdesign für höchste Ansprüche.

#### ONE – NO-ROSETTE DESIGN

ONE is all about minimalism: this range of door handles dispenses entirely with rosettes. The handle is positioned directly on the door and it is suitable for doors with standard locks. In the version with locking mechanism, the locking mechanism is located in the handle neck. A handle designed to meet highest expectations.

AVUS ONE



Griff  
werk



#### AVUS ONE

Rosettenlos | Samtgrau, Graphitschwarz,  
Kaschmirgrau, Gold  
No rosette | velvet grey, graphite black,  
cashmere grey, gold

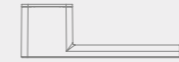

#### smart2lock by GRIFFWERK

#### AVUS ONE

Rosettenlos | Samtgrau, Graphitschwarz,  
Kaschmirgrau, Gold  
No rosette | velvet grey, graphite black,  
cashmere grey, gold

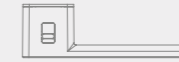

#### R8 ONE

Rosettenlos | Samtgrau, Graphitschwarz,  
Kaschmirgrau  
No rosette | matte stainless steel, graphite grey,  
cashmere grey



#### smart2lock by GRIFFWERK

#### R8 ONE

Rosettenlos | Samtgrau, Graphitschwarz,  
Kaschmirgrau  
No rosette | matte stainless steel, graphite grey,  
cashmere grey



**SCHIEBETÜRGRIFFE FÜR HOLZ- UND GANZGLASTÜREN | EDELSTAHL MATT**  
 SLIDING DOOR HANDLES FOR WOODEN AND FULL GLASS DOORS | MATTE STAINLESS STEEL

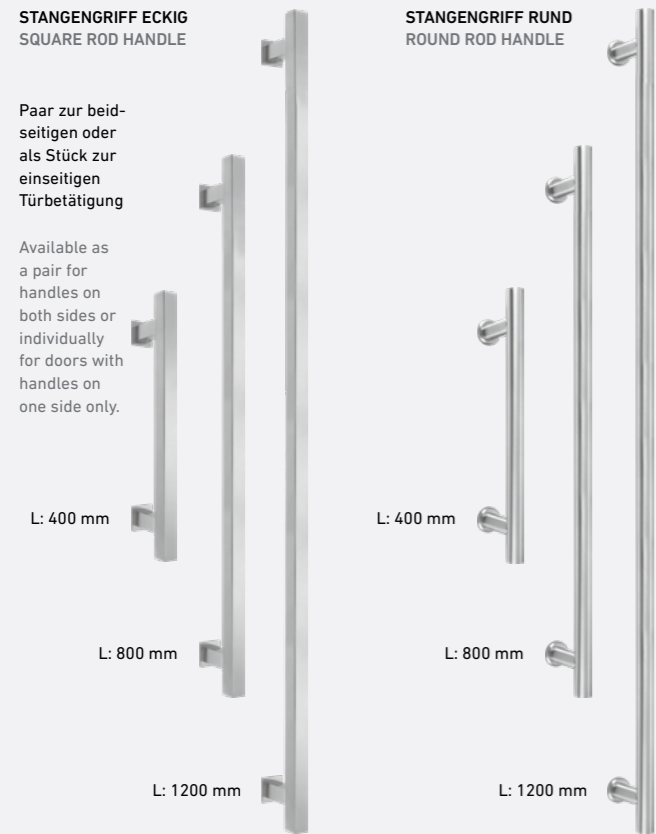

**KLEBEBESCHLÄGE**  
 Beschläge für Ganzglas-Schiebetüren in Edelstahl Mattoptik

**ADHESIVE FITTINGS**  
 Fittings for all-glass doors with a matte stainless steel finish



**SCHIEBETÜRGRIFFE für Holz- und Ganzglastüren | Schwarz\***  
 SLIDING DOOR HANDLES FOR WOODEN AND FULL GLASS DOORS | BLACK\*

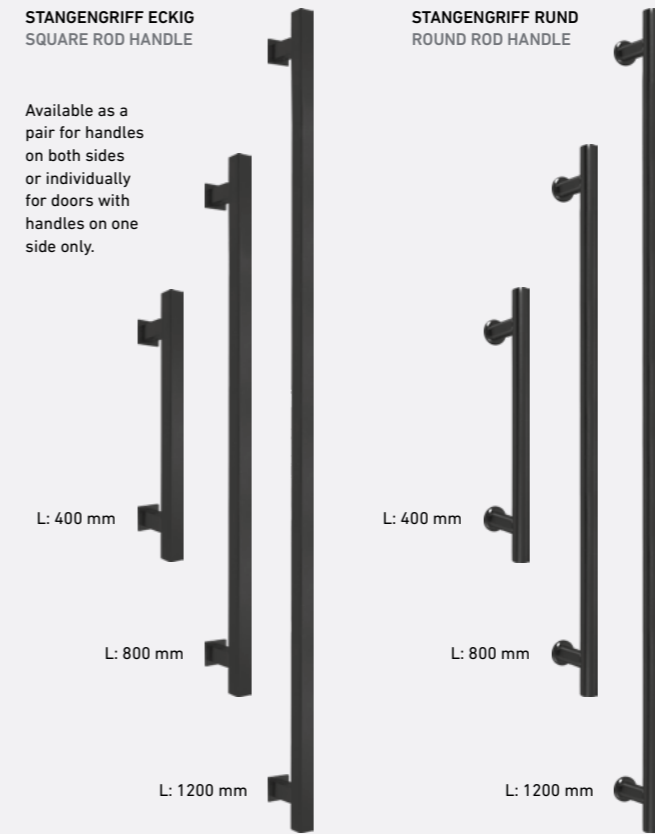

**KLEBEBESCHLÄGE**  
 Beschläge für Ganzglas-Schiebetüren in Edelstahl Mattoptik

**ADHESIVE FITTINGS**  
 Fittings for all-glass doors with a matte stainless steel finish



\*ähnlich RAL9005 \*like RAL9005

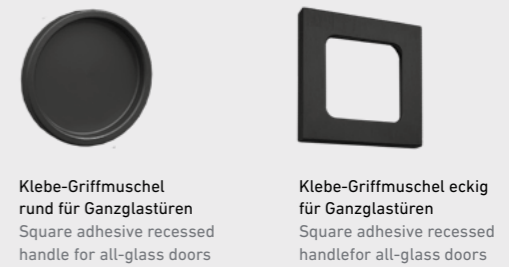
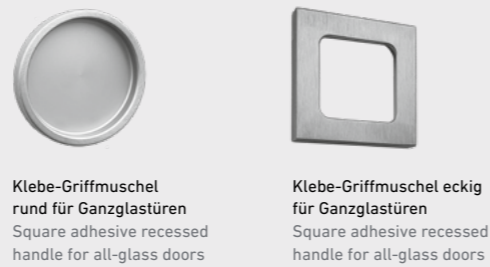

# Kleine Rundkante an Türblättern und Zargen in Weißlack 9016

Small rounded edges on the door leaf and frames in white varnish 9016

GARANT Türen und Zargen in Weißlack 9016 sind mit einer kleinen Rundkante (KR) verfügbar.  
GARANT doors and frames in white varnish 9016 are available with a small rounded edge (KR).

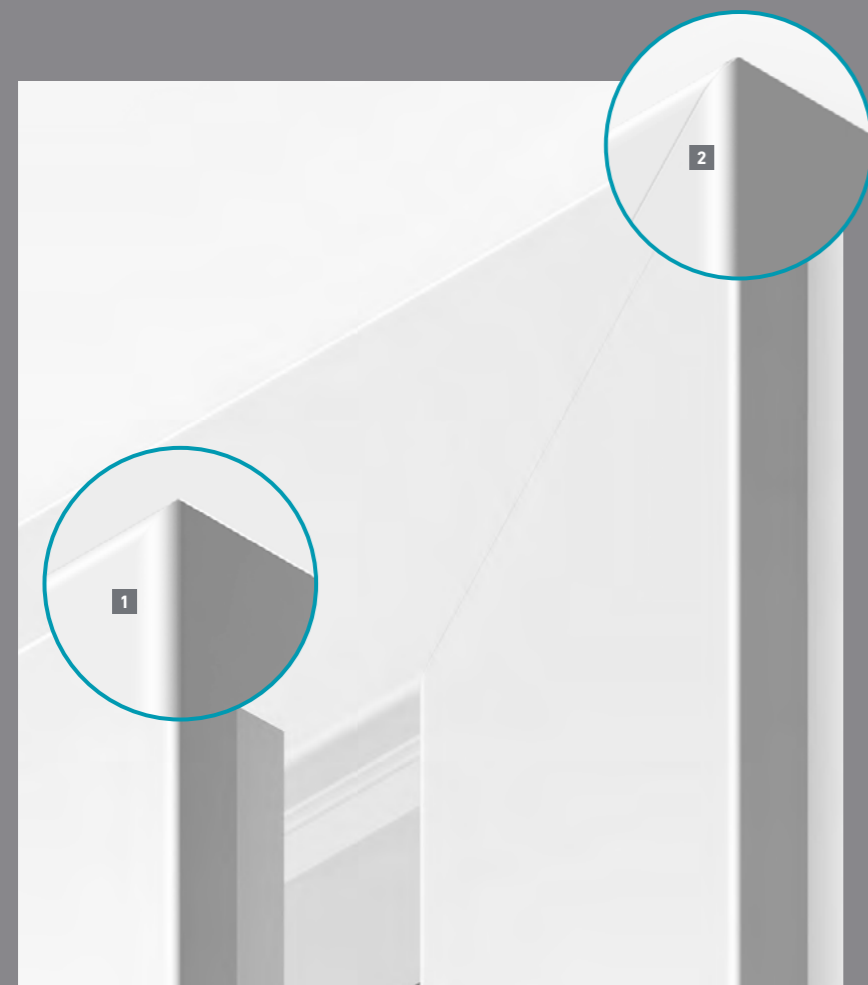

- 1** **NORMTÜR**  
Kleine Rundkante
- 2** **NORMZARGE KR1**  
Bekleidung kleine Rundkante (60 mm)  
Futterplatte rund
- 1** **STANDARD DOOR**  
Small rounded edge
- 2** **STANDARD FRAME KR1**  
Casing with a small rounded edge (60 mm)  
Rounded jamb

# Breite Zargenbekleidungen machen den Unterschied

Les chambranles larges font la différence

Verbessern auch Sie die Optik Ihrer Türen durch breitere Zargen-Bekleidungen!  
Améliorer également l'optique de vos portes à travers des chambranles plus larges!



## QUERSCHNITT | CROSS SECTION

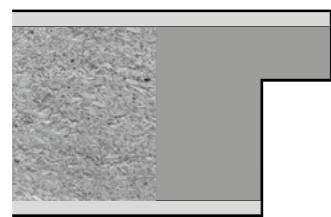

ECKIGE KANTE (E)  
SQUARE EDGE (E)

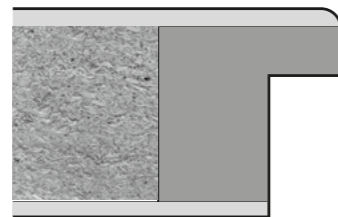

KLEINE RUNDKANTE (KR)  
SMALL ROUNDED EDGE (KR)

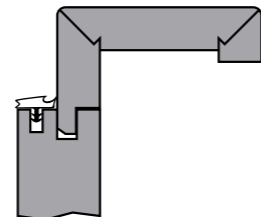

ZARGE MIT KLEINER RUNDKANTE,  
60 MM BEKLEIDUNG  
FRAME WITH SMALL ROUNDED EDGE,  
60 MM CASING

ZARGE: 60 MM BEKLEIDUNG  
FRAME: CASING 60 MM

-  WEISSLACK 9016  
WHITE VARNISH 9016
-  WEISSLACK 9010  
WHITE VARNISH 9010

ZARGE: 100 MM BEKLEIDUNG  
FRAME: CASING 100 MM

-  WEISSLACK 9016  
WHITE VARNISH 9016

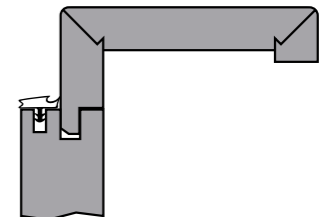

ZARGE MIT KLEINER RUNDKANTE,  
100 MM BEKLEIDUNG  
FRAME WITH SMALL ROUNDED EDGE,  
100 MM CASING

# Türkanten und Zargenausführungen im Überblick

## Overview of door edges and frames



**NORMTÜR**  
Runde Kante

**NORMZARGE R1**  
Bekleidung rund  
(60 und 75 mm)  
Futterplatte rund

**STANDARD DOOR**  
Rounded edge

**STANDARD FRAME R1**  
Rounded casing  
(60 and 75 mm)  
Rounded jamb



**NORMTÜR**  
Eckige Kante

**NORMZARGE E1**  
Bekleidung eckig  
(55 und 75 mm)  
Futterplatte eckig

**STANDARD DOOR**  
Square edge

**STANDARD FRAME E1**  
Square casing  
(55 and 75 mm)  
Square jamb



**NORMTÜR**  
Kleine Rundkante

**NORMZARGE KR1**  
Bekleidung kleine Rundkante  
(60 mm)  
Futterplatte rund

**STANDARD DOOR**  
Small rounded edge

**STANDARD FRAME KR1**  
Casing with a small rounded edge  
(60 mm)  
Rounded jamb

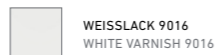

**NORMTÜR**  
Kleine Rundkante

**NORMZARGE KR1**  
Bekleidung kleine Rundkante  
(100 mm)  
Futterplatte rund

**STANDARD DOOR**  
Small rounded edge

**STANDARD FRAME KR1**  
Casing with a small rounded edge  
(100 mm)  
Rounded jamb



**NORMTÜR**  
Runde Kante

**NORMZARGE P1**  
Bekleidung profiliert  
(75 mm)  
Futterplatte rund

**STANDARD DOOR**  
Rounded edge

**STANDARD FRAME P1**  
Profiled casing  
(75 mm)  
Profiled jamb



**NORMTÜR STUMPF**  
Stumpfe Kante

**NORMZARGE SE1**  
Bekleidung eckig  
(55 mm)  
Futterplatte eckig

**STANDARD FLUSH-FITTED DOOR**  
Flush edge

**STANDARD FRAME SE1**  
Square casing  
(55 mm)  
Square jamb



**NORMTÜR STUMPF**  
Stumpfe Kante

**NORMZARGE SR1**  
Bekleidung rund  
(60 mm)  
Futterplatte rund

**STANDARD FLUSH-FITTED DOOR**  
Flush edge

**STANDARD FRAME SR1**  
Rounded casing  
(60 mm)  
Rounded jamb



**NORMTÜR STUMPF**  
Stumpfe Kante

**NORMZARGE SKR1**  
Bekleidung kleine Rundkante  
(60 mm)  
Futterplatte rund

**STANDARD FLUSH-FITTED DOOR**  
Flush edge

**STANDARD FRAME SKR1**  
Casing with a small rounded edge  
(60 mm)  
Rounded jamb



# Ausführungen gefälzt und stumpf

## Rebated and flush versions



Gefälzte Türansicht  
View of a rebated door

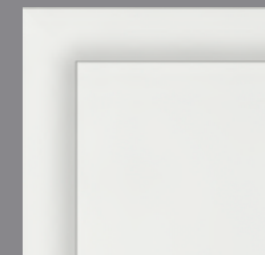

Detailansicht  
Detailed view



2-tlg. Band  
(gefälzte Türen)  
2-part hinge  
(rebated door)

3-tlg. Band  
(gefälzte Türen)  
2-part hinge  
(rebated door)



Stumpfe Türansicht  
View of a flush-fitted door

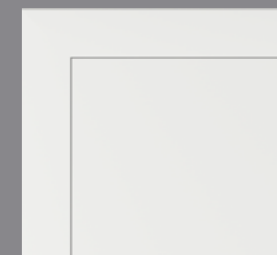

Detailansicht  
Detailed view



Verdeckte Bänder  
bei stumpfen Türen  
Concealed hinges  
(flush-fitted doors)

# Blockrahmen und Blendrahmen

## Block frames and blind frames

Aufbau Blockrahmen  
Block frame construction

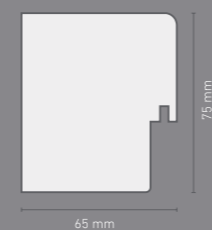

Wandprofil  
Wall edge

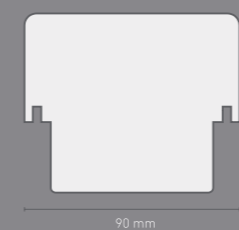

Kämpfer / Pfosten  
Traverse / Pole

Aufbau Blendrahmen  
Blind frame construction



Wandprofil  
Wall edge

# Sieht gut aus. Fühlt sich gut an. Looks good. Feels good.

Unsere hochwertig Weißlackoberflächen  
Our premium white varnished finishes

## WEISSLACK-EIGENSCHAFTEN

Unsere Weißlackoberfläche ähnelt dem RAL-Farbtönen 9016 oder 9010. Ein umweltfreundliches Walzlackierverfahren ermöglicht optimalen Grundier- und Lackauftrag. Nach einer Hydro-Grundierung erfolgt ein mehrfacher Acryllackauftrag, der UV-gehärtet wird.

Bei profilierten Oberflächen kommt eine Kombination aus Walzverfahren und Spritzverfahren zum Einsatz. Hierbei werden die Profile manuell im Spritzverfahren grundiert. Anschließend werden im Walzverfahren die glatten Flächen mit Hydro-Grundierung versehen. Als Letztes erfolgt ein mehrfacher Acryllackauftrag mittels Spritzroboter, der mit einer UV-Härtung abgeschlossen wird. Das Ergebnis ist eine griffsympathische, seidenmatte Weißlackoberfläche.

## WHITE VARNISH PROPERTIES

Our white varnish finish is similar in colour to RAL 9016 or 9010. An eco-friendly roller coating process ensures the optimum application of the primer and varnish. The hydro primer is followed by several layers of UV-hardened acrylic varnish.

A combination of roller and spray coating is used for profiled finishes. The profiles are primed manually by spray coating. Then the smooth surfaces are primed with hydro primer in a roller coating process. The final stage in the process is the application of multiple layers of acrylic varnish by spraying robots and UV hardening. The result is a pleasant-to-touch, silk-matte, white varnish finish.



# Weißlack mit Funktion Functional white varnish

Alle Türen mit Weißlack-Oberflächen können auch als Funktionstür ausgestattet werden. Hier steht die volle Bandbreite von Türen mit Barrierefreiheit über einbruchssichere Türen, Türen mit Schall- und Wärmeschutz bis zur Brandschutztür zur Auswahl.

All doors with white varnish finishes can be functional doors. There are a wide range of options in this respect, from accessibility doors to anti-burglary doors, doors with heat and noise insulation and fire doors.

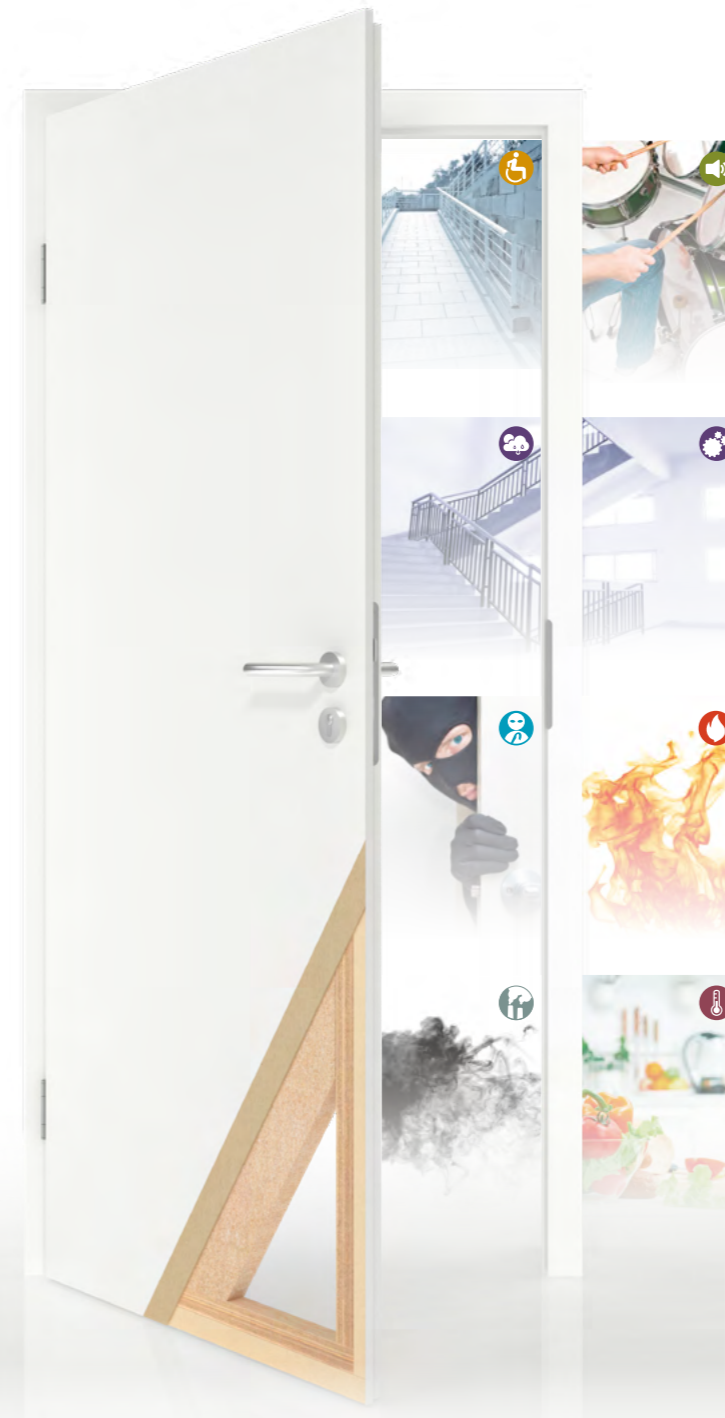

**BARRIEREFREIHEIT**  
ACCESSIBILITY



**KLIMASTABILITÄT**  
CLIMATE STABILITY



**MECHANISCHE BEANSPRUCHUNG**  
MECHANICAL STRESS



**SCHALLSCHUTZ**  
NOISE INSULATION



**EINBRUCHSCHUTZ**  
ANTI-BURGLARY



**FEUERSCHUTZ**  
FIRE PROTECTION



**RAUCHSCHUTZ**  
SMOKE PROTECTION



**WÄRMEDÄMMSCHUTZ**  
HEAT INSULATION

# Weißlack mit Funktion

## White varnish functional doors

Unsere Funktionstüren schützen Sie und Ihre privaten oder geschäftlichen Räume und Güter vor den unterschiedlichsten negativen Einflüssen wie Schall, Einbruch, Feuer und Rauch.

Our functional doors protect you, your home and your business premises and assets from the diverse negative effects of noise, burglary, fire and smoke.



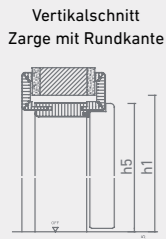
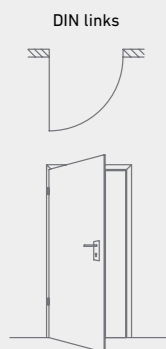
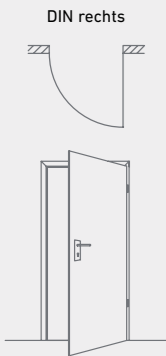

TÜRBLATTGRÖSSEN (VORZUGSGRÖSSEN NACH DIN 18101)											
EINFLÜGELIGE TÜREN						ZWEIFLÜGELIGE TÜREN					
Wandöffnungsmaß		Türblatt-Außenmaße				Wandöffnungsmaß		Türblatt-Außenmaße			
		Gefälztes Türblatt		Ungefälztes Türblatt				Gefälztes Türblatt		Ungefälztes Türblatt	
Breite (b1)	Höhe (h1)	Breite (b5)	Höhe (h5)	Breite (b5)	Höhe (h5)	Breite (b1)	Höhe (h1)	Breite (b5)	Höhe (h5)	Breite (b5)	Höhe (h5)
635	2005	610	1985	584	1972	1260	2005	1210	1985	1184	1972
760	2005	735	1985	709	1972	1510	2005	1460	1985	1434	1972
885	2005	860	1985	834	1972	1760	2005	1710	1985	1684	1972
1010	2005	985	1985	959	1972	2010	2005	1960	1985	1934	1972
1135	2005	1110	1985	1084	1972	2350	2005	2210	1985	2184	1972
1260	2005	1235	1985	1209	1972	2600	2005	2460	1985	2434	1972
635	2130	610	2110	584	2097	1260	2130	1210	2110	1184	2097
760	2130	735	2110	709	2097	1510	2130	1460	2110	1434	2097
885	2130	860	2110	834	2097	1760	2130	1710	2110	1684	2097
1010	2130	985	2110	959	2097	2010	2130	1960	2110	1934	2097
1135	2130	1110	2110	1084	2097	2350	2130	2210	2110	2184	2097
1260	2130	1235	2110	1209	2097	2600	2130	2460	2110	2434	2097

1. Normalhöhe nach DIN 18100 (Nennmaß) (h1)	2005						2130							
Maueröffnungshöhe min.-max. in [mm] (h1)	2000-2015*						2125-2140*							
Türblattaußenmaße in [mm] (h5)	1985						2110							
2. Normalbreite (1 flg.) nach DIN 18100 (Nennmaß) (b1)	635			885			1010			1260				
Maueröffnungsbreite min.-max. in [mm] (b1)	625-645*			875-895*			1000-1020*			1250-1270*				
Türblattaußenmaße in [mm] (b5)	610			860			985			1235				
3. Normalbreite (2 flg.) nach DIN 18100 (Nennmaß)	1260			1510			1760			2010				
Maueröffnungsbreite min.-max. in [mm]	1250-1270*			1500-1520*			1750-1770*			2000-2020*				
Türblattaußenmaße in [mm]	1210			1460			1710			1960				
* Bei Einsatz einer Holzumfassungszarge empfiehlt GARANT das Maximalmaß.														
4. Verstellbarkeit in [mm]	80-100	100-120	120-140	140-160	160-180	180-200	200-220	215-235	235-255	255-275	265-285	285-305	305-320	320-340
Futterbreite/Wanddicke	85	105	125	145	165	185	205	220	240	260	270	290	310	325

ZUBEHÖR

SCHLÖSSER

DICHTUNG



MODELL: BUNTART-SCHLOSS



MODELL: PROFILZYLINDER-SCHLOSS



MODELL: SCHLOSS FÜR BADTÜREN



MODELL: ABSENKBARE BODENDICHTUNG

BÄNDER



MODELL: BANDKOMBINATION V 3420 WF FÜR HOLZZARGE

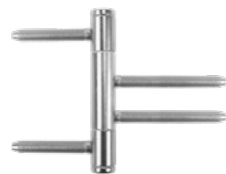

MODELL: BANDKOMBINATION V 4426 WF FÜR HOLZZARGE



MODELL: BANDKOMBINATION V 8026 WF FÜR STAHLZARGE

DOOR LEAF SIZES (STANDARD SIZES AS PER DIN 18101)											
SINGLE-LEAF DOORS						DOUBLE-LEAF DOORS					
Wall aperture measurements		Door leaf external measurements				Wall aperture measurements		Door leaf external measurements			
		Rebated door leaf		Flush door leaf				Rebated door leaf		Flush door leaf	
Length (b1)	Height (h1)	Length (b5)	Height (h5)	Length (b5)	Height (h5)	Length (b1)	Height (h1)	Length (b5)	Height (h5)	Length (b5)	Height (h5)
635	2005	610	1985	584	1972	1260	2005	1210	1985	1184	1972
760	2005	735	1985	709	1972	1510	2005	1460	1985	1434	1972
885	2005	860	1985	834	1972	1760	2005	1710	1985	1684	1972
1010	2005	985	1985	959	1972	2010	2005	1960	1985	1934	1972
1135	2005	1110	1985	1084	1972	2350	2005	2210	1985	2184	1972
1260	2005	1235	1985	1209	1972	2600	2005	2460	1985	2434	1972
635	2130	610	2110	584	2097	1260	2130	1210	2110	1184	2097
760	2130	735	2110	709	2097	1510	2130	1460	2110	1434	2097
885	2130	860	2110	834	2097	1760	2130	1710	2110	1684	2097
1010	2130	985	2110	959	2097	2010	2130	1960	2110	1934	2097
1135	2130	1110	2110	1084	2097	2350	2130	2210	2110	2184	2097
1260	2130	1235	2110	1209	2097	2600	2130	2460	2110	2434	2097

1. Standard height as per DIN 18100 (nominal height) (h1)	2005						2130							
Wall aperture height min.-max. in [mm] (h1)	2000-2015*						2125-2140*							
Door leaf external measurements [mm] (h5)	1985						2110							
2. Standard height (single leaf) as per DIN 18100 (nominal height) (b1)	635			885			1010			1260				
Wall aperture width min.-max. in [mm] (b1)	625-645*			875-895*			1000-1020*			1250-1270*				
Door leaf external measurements [mm] (b5)	610			860			985			1235				
3. Standard height (double leaf) as per DIN 18100 (nominal height) (b1)	1260			1510			1760			2010				
Wall aperture width min.-max. in [mm]	1250-1270*			1500-1520*			1750-1770*			2000-2020*				
Door leaf external measurements [mm]	1210			1460			1710			1960				
* GARANT recommends the maximum size if a closed wooden frame is being used.														
4. Adjustability in [mm]	80-100	100-120	120-140	140-160	160-180	180-200	200-220	215-235	235-255	255-275	265-285	285-305	305-320	320-340
Jamb width/ wall thickness	85	105	125	145	165	185	205	220	240	260	270	290	310	325

ACCESSORIES

LOCKS

SEALS



MODEL: WARDER KEY LOCK



MODEL: PROFILE CYLINDER LOCK



MODEL: BATHROOM DOOR LOCK



MODEL: LOWERABLE BOTTOM SEAL

HINGES



MODEL: HINGE COMBINATION V 3420 WF FOR WOODEN FRAMES



MODEL: HINGE COMBINATION V 4426 WF FOR WOODEN FRAMES



MODEL: HINGE COMBINATION V 8026 WF FOR STEEL FRAMES

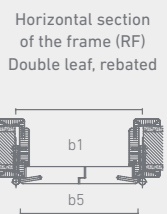
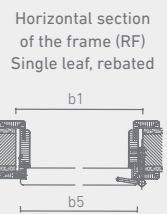
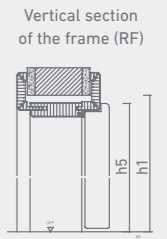
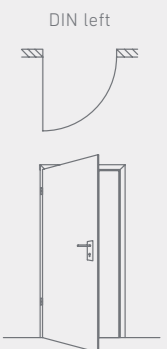
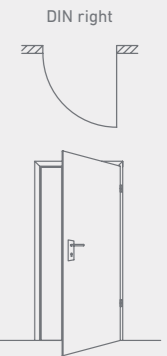



NORMTÜREN  
STANDARD DOOR

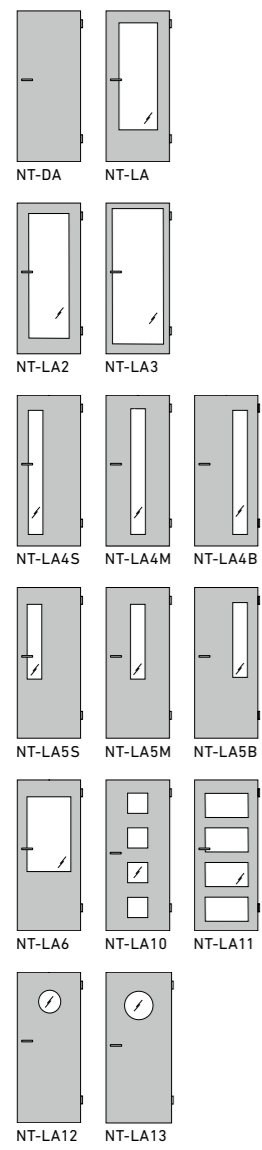

AMRUM  
AMRUM

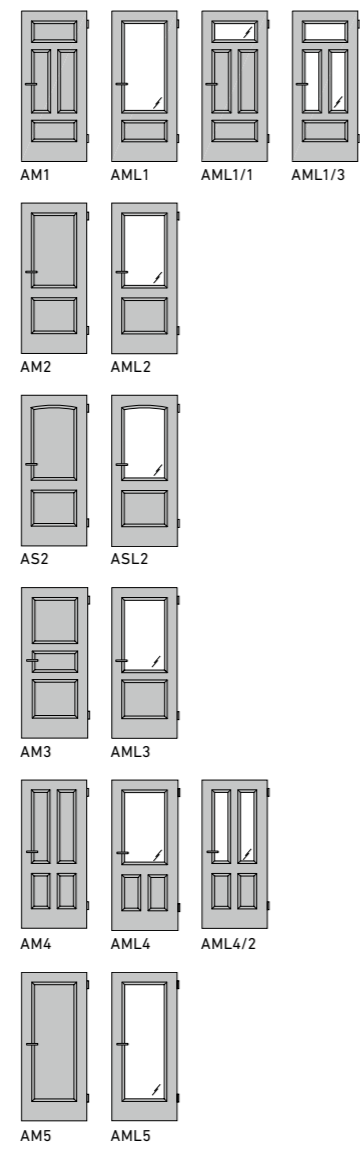

AURA  
AURA

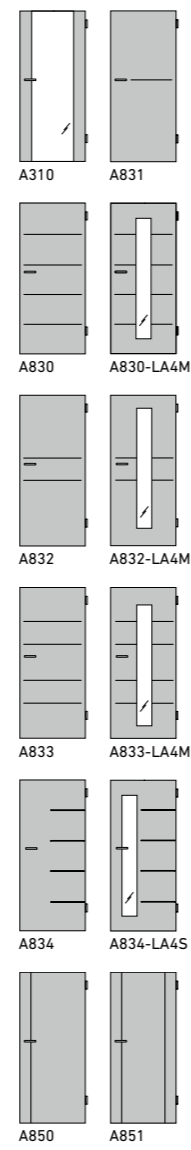

MILANO  
MILANO

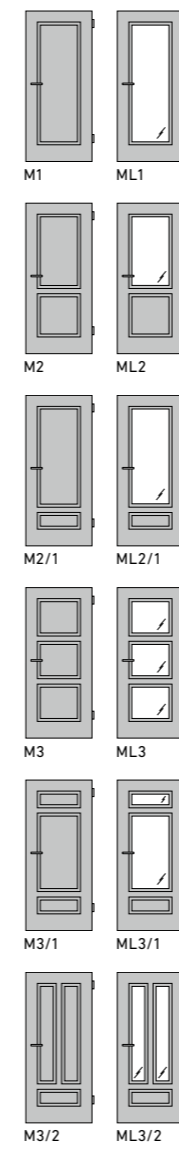

RIVA  
RIVA

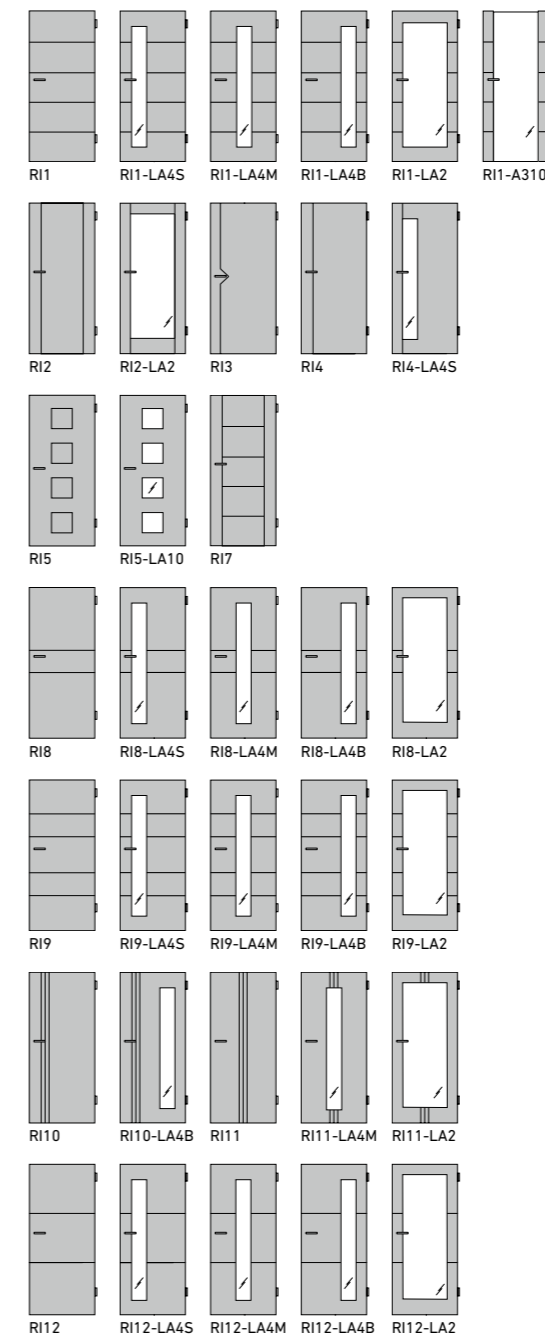

COMO  
COMO

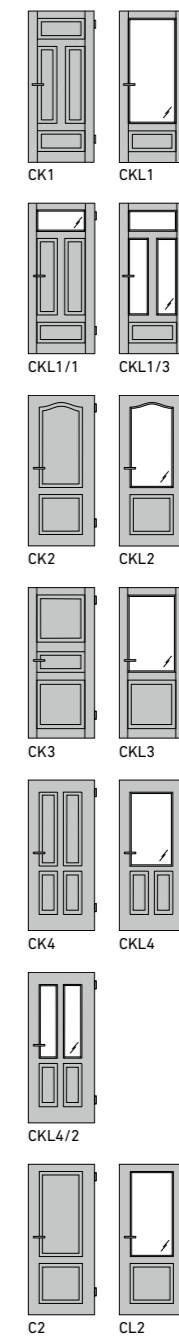

PARMA  
PARMA

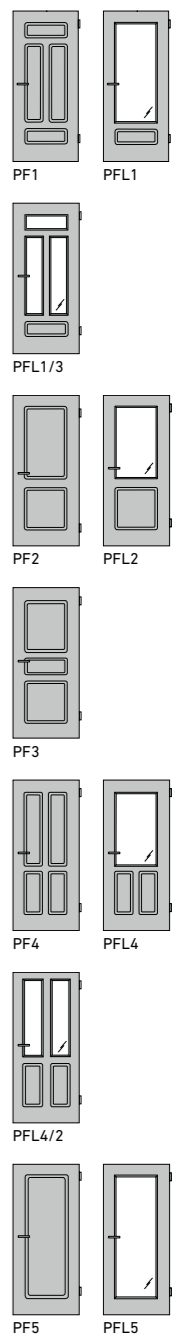

OBERFLÄCHEN | FINISHES



WEISSLACK 9016,  
WEISSLACK 9010



WEISSLACK 9016,  
WEISSLACK 9010

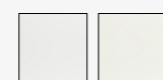

WEISSLACK 9016,  
WEISSLACK 9010



WEISSLACK 9016,  
WEISSLACK 9010



WEISSLACK 9016,  
WEISSLACK 9010

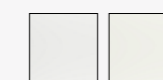

WEISSLACK 9016,  
WEISSLACK 9010



WEISSLACK 9016,  
WEISSLACK 9010

GANZGLASTÜREN DESIGN  
ALL-GLASS DESIGN DOORS

LASER-VEREDELUNG | LASER DÉCOR

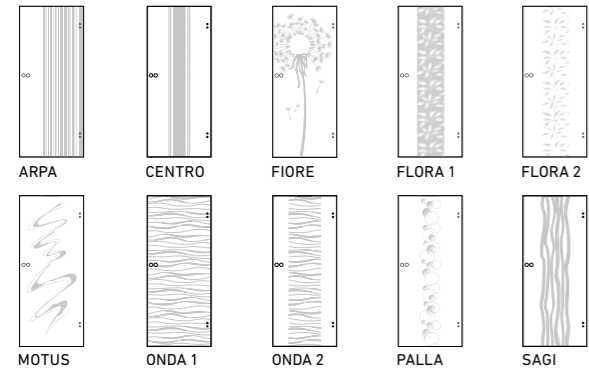

SIEBDRUCK-VEREDELUNG | SCREEN PRINTED DÉCOR

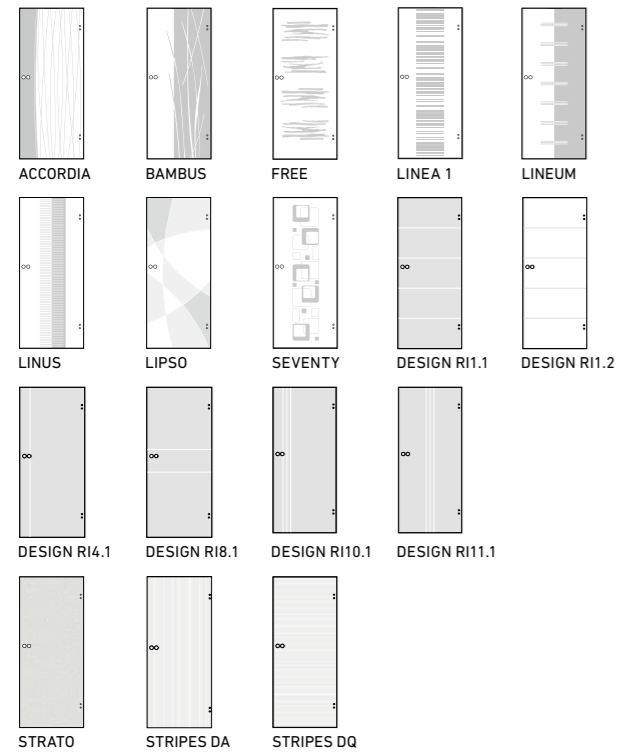

GANZGLASTÜREN ORNAMENT (NORM)  
PATTERNED ALL-GLASS DOORS (STANDARD)

STANDARD-ORNAMENTGLAS | STANDARD PATTERNED GLASS

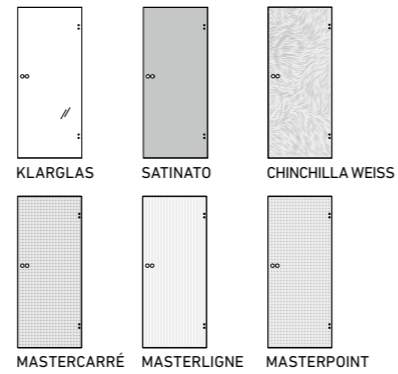

DESIGN-ORNAMENTGLAS | DESIGN PATTERNED GLASS

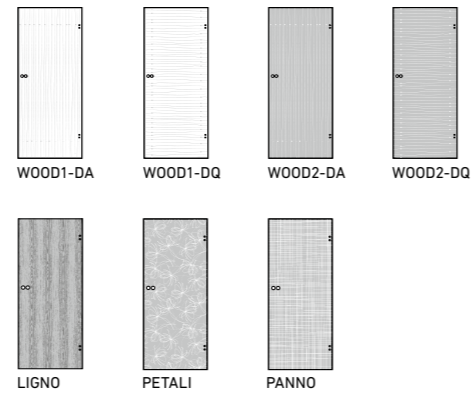

LICHTAUSSCHNITTGLÄSER  
GLASS PANELS

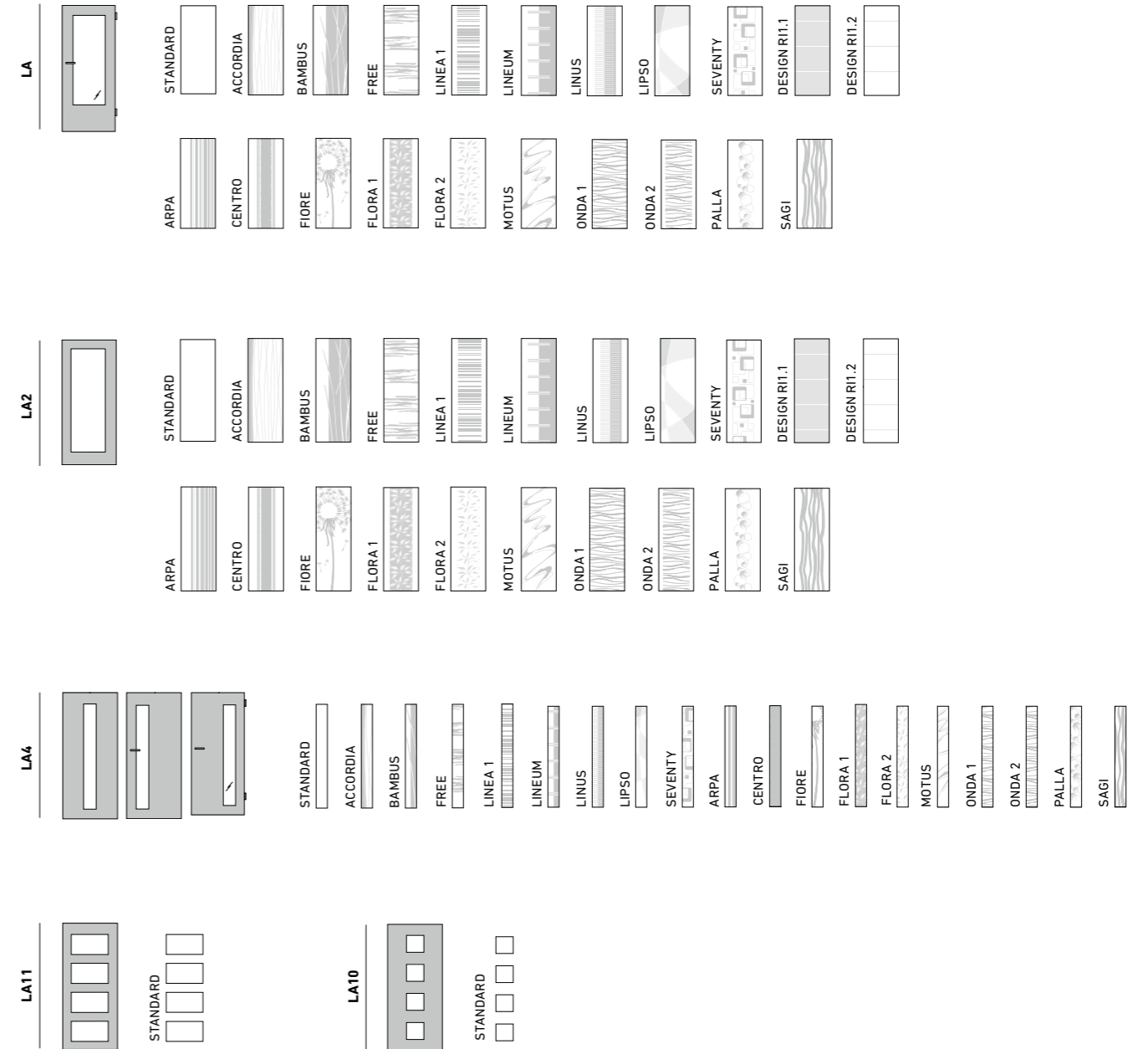

GLASBEISPIELE  
EXAMPLES OF GLASS

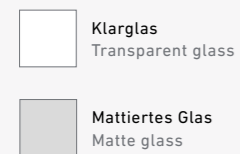

STANDARD-LICHTAUSSCHNITTGLÄSER ALS ORNAMENTGLAS  
STANDARD PATTERNED GLASS PANELS

- STANDARD-ORNAMENTGLÄSER**
- KLARGLAS
  - SATINATO
  - MASTERCARRÉ
  - MASTERLIGNE
  - MASTERPOINT
  - CHINCHILLA WEISS

- DESIGN-ORNAMENTGLÄSER**
- LIGNO
  - PETALI
  - PANNO
  - WOOD1-DA
  - WOOD1-DQ
  - WOOD2-DA
  - WOOD2-DQ

SPROSSENRAHMEN  
MUNTIN FRAMES

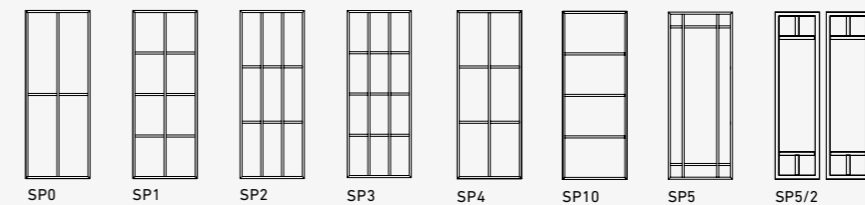

## GARANT Türen und Zargen GmbH

OT Ichtershausen  
Garantstraße 1, Gewerbepark Thörey  
99334 Amt Wachsenburg

T +49 (0) 36202/91-0  
F +49 (0) 36202/91-150  
E [service@garant.de](mailto:service@garant.de)  
I [www.garant.de](http://www.garant.de)

Ein Unternehmen der Arbonia Doors

**ARBONIA**   
Doors

Ihr GARANT-Fachhändler:



Hauptstraße 69 • 91355 Hiltpoltstein

 09192 7887  
 [info@pruetting.de](mailto:info@pruetting.de)  
 [www.pruetting.de](http://www.pruetting.de)



 **GARANT**  
Türen für mein Zuhause

Stand 05/2023

Drucktechnisch bedingte Farbabweichungen  
sowie Änderungen am Produkt vorbehalten.

Gestaltung: Zentral-Marketing GARANT

Nur die mit FSC® gekennzeichneten Produkte sind zertifiziert.\*



MITGLIED DER



**GÜTE  
GEMEINSCHAFT  
INNENTÜREN**